

RS *Feva*

Rigging Manual V5



RS
Feva

Contents

1. INTRODUCTION

2. RS FEVA TECHNICAL DATA

3. COMMISSIONING

- 3.1 Preparation
- 3.2 Unpacking
- 3.3 Rigging the [Mast](#)
- 3.4 Rigging the [Jib](#)
- 3.5 Rigging the mast for the [Gennaker](#)
- 3.6 Stepping the [Mast](#)
- 3.7 Rigging the [Kicker](#)
- 3.8 Rigging the [Boom](#)
- 3.9 The [Daggerboard](#)
- 3.10 The Rudder
- 3.11 Hoisting the [Mainsail](#)
- 3.12 Hoisting the [Jib](#)
- 3.13 Rigging the [Gennaker](#)
- 3.14 Completion

4. SAILING HINTS

- 4.1 Introduction
- 4.2 Launching
- 4.3 Leaving the Beach
- 4.4 Sailing Close-Hauled and Tacking
- 4.5 Sailing Downwind and Gybing
- 4.6 Using the [Gennaker](#)
- 4.7 Reefing

5. MAINTENANCE

- 5.1 Boat Care
- 5.2 Foil Care
- 5.3 Spar Care
- 5.4 Sail Care
- 5.5 Fixtures & Fittings

6. WARRANTY

7. GLOSSARY

All terms highlighted in [blue](#) throughout the manual can be found in the Glossary of Terms.

1. Introduction

Congratulations on the purchase of your new RS Feva and thank you for choosing an RS product. We are confident that you will have many hours of great sailing and racing in this truly excellent design.

The RS Feva is an exciting boat to sail and offers fantastic performance. This manual has been compiled to help you to gain the maximum enjoyment from your RS Feva, in a safe manner. It contains details of the craft, the equipment supplied or fitted, its systems, and information on its safe operation and maintenance. Please read this manual carefully and be sure that you understand its contents before using your RS Feva.

This manual will not instruct you in boating safety or seamanship. If this is your first boat, or if you are changing to a type of craft that you are not familiar with, for your own safety and comfort, please ensure that you have adequate experience before assuming command of the craft. If you are unsure, RS, your [RS dealer](#), or your [national sailing federation](#) – for example, the Royal Yachting Association – will be able to advise you of a local sailing school, or a competent instructor.

RS Sailing highly recommends using RS supplied equipment for usage and storing of your craft. Deviation from using RS supplied equipment, such as sails and storage solutions, will require consultation with RS Sailing. Failure to do so may affect Warranty claims and Goodwill outcomes.

Please keep this manual in a secure place and hand it over to the new owner if you sell the boat.

For further information, spares, and accessories, please contact:

RS Sailing
Premier Way
Abbey Park
Romsey
Hants SO51 9DQ
Tel.: +44(0)1794 526760
Fax: +44(0)1794 278418
E-mail: www.info@rssailing.com

For details on your local RS dealer, please visit www.rssailing.com

2. *RS* *Feva* Technical Data

Length Overall (LOA)	3.64m	12'0"
Beam	1.42m	4'8"
Hull Weight	68kg	136lb
Reefing Mainsail	5.5m ²	57sq ft
3 Batten Mainsail	6.5m ²	68sq ft
Jib	2.1m ²	22sq ft
Gennaker	7.0m ²	73sq ft

3. Commissioning

3.1 Preparation

Your RS Feva comes complete with all the components necessary to take the boat sailing. In order to commission it, you will need the following tools:

- Pliers, or a shackle key
- PVC Electrician's Tape





You may require other tools later, should you wish to make any setting or tuning adjustments to the boat or the rig.

DO NOT use a knife or other sharp object to cut through packaging containing parts – you may damage the contents!





Whilst your RS Feva has been carefully prepared, it is important that new owners should check that **shackles** and knots are tight. This is especially important when the boat is new, as travelling can loosen seemingly tight fittings and knots. It is also important to check such items regularly prior to sailing.

Having unpacked your RS Feva, you should check that you have all of the items listed below before throwing away any of the packing, as there may be some small items still wrapped.



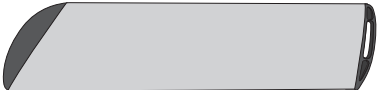



Boat Pack:

	QUANTITY	COMPONENT
	1	Hull
	1	Lower mast
	1	Top mast
	1	Boom
	1	Document bag
	1	Owner's manual



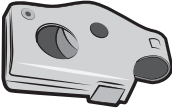

Foil Kit:

	QUANTITY	COMPONENT
	1	Dagger Blade
	1	Rudder Blade
	1	Rudder Stock
	1	Tiller
	1	Tiller Extension

Customer Fittings Pack:

	QUANTITY	COMPONENT
	1	Englefield Clip
	1	Plastic Bobble
	1	Nylon Spring Hook
	3	20mm block
	1	Single Jam Block and Becket
	1	100mm Dacron Patch.

Rope Pack:

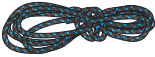
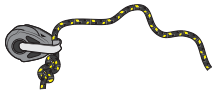
	QUANTITY	COMPONENT
	1	Mainsheet
	1	Main Halyard
	1	Downhaul
	1	Boom Strop
	1	Jib Sheet
	1	Jib Halyard
	1	Jib Halyard Block

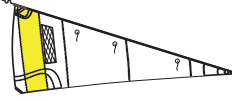
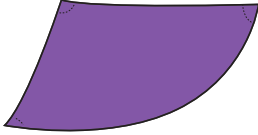

S Sail Pack:

	QUANTITY	COMPONENT
	1	S Mainsail
	1	Club Jib
	1	Spinnaker

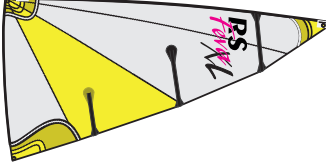
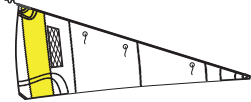
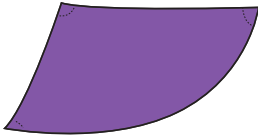
XL Club Sail Pack:

	QUANTITY	COMPONENT
	1	XL Mainsail
	1	Club Jib
	1	Spinnaker

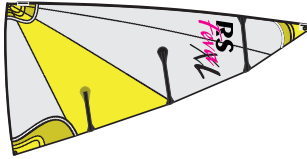
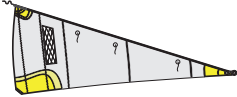
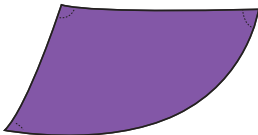
XL Race Sail Pack

	QUANTITY	COMPONENT
	1	XL Mainsail
	1	XL Jib
	1	Spinnaker
	1	Race Pack

If you have the **Jib** and/or **Gennaker** Pack, please refer to Section 3.4 Rigging the **Jib**, and Section 3.11 Rigging the **Gennaker** before stepping the **mast** in the boat.

To complete this section, you will need:

- The **mast top section**
- The **mast lower section**
- The **main halyard**

- a)
- Place the **mast top section** and **mast lower section** on the ground, in line with each other.



- b)
- Slide the inner sleeve of the **mast top section** into the end of the **mast lower section**.
 - Push the two **mast** sections together. The angle of the join should ensure that the **mast track** on the two sections aligns.



- c)
- Uncoil the **main halyard**
 - Thread one end of the **main halyard** through the bullseye at the top of the **mast**.
 - Run both ends of the **main halyard** to the bottom of the **mast** and tie in place (this prevents them from disappearing back up the **mast**!).

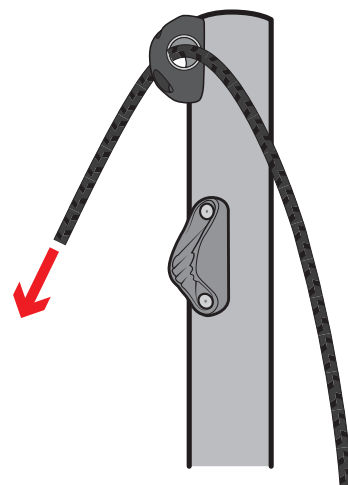

Please note, top and bottom **mast** sections are matched, they are not interchangeable so if you have more than one boat you should consider marking the sections to identify which go together.

RS
Feva 3.3 - Rigging the **Mast**

d)



BEFORE PICKING UP THE **MAST, CHECK THAT YOU ARE NOT IN THE VICINITY OF OVERHEAD POWER CABLES**

REMEMBER

If you are rigging the **Jib** and **Gennaker** Packs, you need to read Sections 3.4 and 3.10 before stepping the **mast**

Now the **mast** is ready to be put up in the boat, or 'stepped'.

RS
Feva 3.4 - Stepping the **Mast**

The Mast Gate Pin

The **mast**-gate pin is already fitted to your Feva. The pin has a locking nut on the bottom to prevent it from falling out.

To close the mechanism:

- 1) Push the Pin through the gate from above.
- 2) Screw down the knurled nut until it is tight.

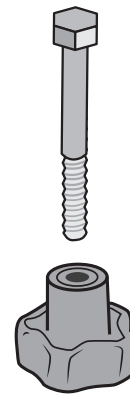

a)

- Remove the **mast gate pin** from the hole and open the **mast gate**.

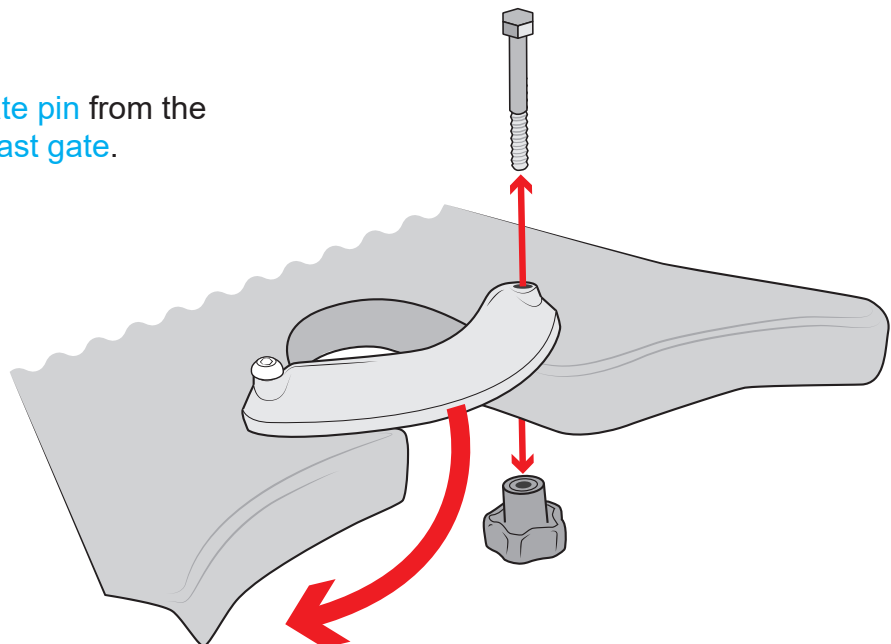

To complete this section, you will need:

- 1 x Feva **jib**
- 2 x Feva **shrouds**
- 1 x **shroud shackle**
- 1 x **jib halyard block**
- 1 x **jib halyard**
- 1 x **jib sheet**
- 1 x **jib halyard block tie**

Before stepping the **mast** you will need to complete the following steps:

- a)
- Hook the eyelets at the end of the **shrouds** onto the **shroud shackle**.

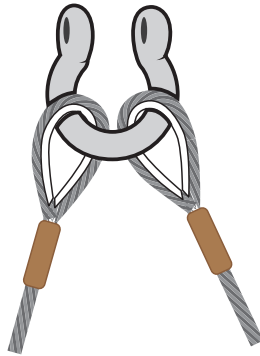

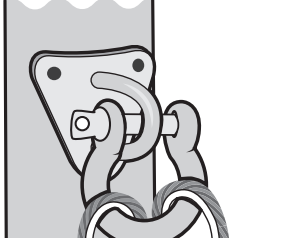
- b)
- 
- A diagram showing a metal shackle being attached to a metal ring on the mast. The shackle is hooked onto the lower of two metal rings on the front face of the mast. The ropes have brown handles at their bottom ends.
- Attach the **shroud shackle** to the lower of the two metal rings on the front face of the **mast**.

- c)
- Tie **knot #1** in one end of the **jib halyard block tie**.

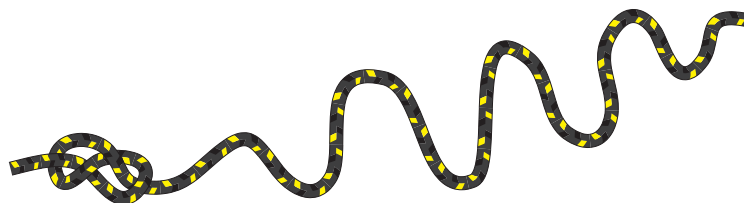

RS
Feva 3.4 - Rigging the **Jib**

- d)
- Thread the other end of the **jib halyard block** tie through the metal loop at the top of the **jib halyard block**, pulling the excess through until the **block** is next to the knot.

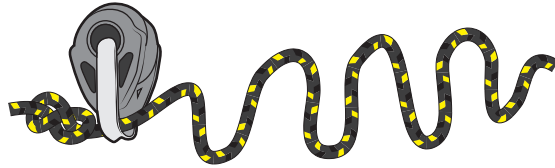

- e)
- Thread the free end of the **jib halyard block** tie through the **shroud** shackle, in between the **shrouds**.

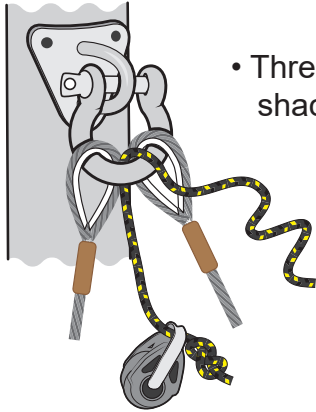

- f)
- Thread the end of the **jib halyard block** tie back through the metal loop at the top of the **jib halyard block**, passing through **in the opposite direction to step d**.

- Tie **knot #3** in the end of the **jib halyard block** tie. The **jib halyard block** will now hang just below the lower of the two metal rings on the front face of the mast.

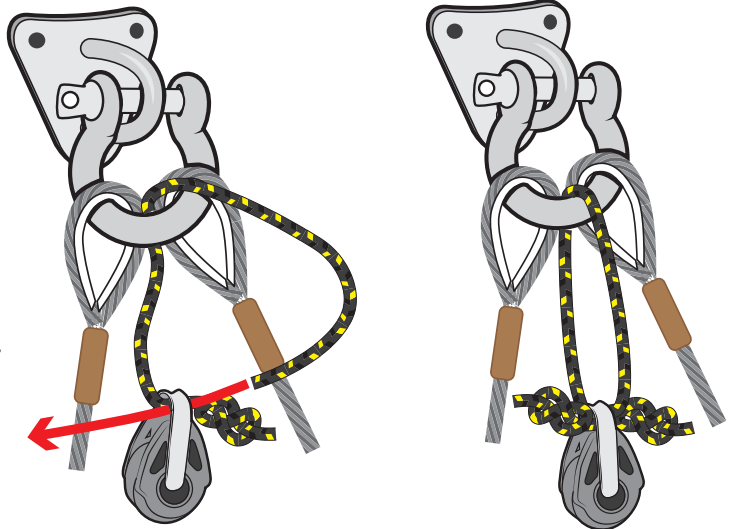

- g)
- Thread the **jib halyard** through the **jib halyard block**, and make sure that both ends of the **jib halyard** are secure at the bottom of the mast.

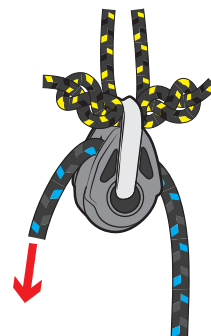

RS Feva 3.5 - Rigging the mast for the Gennaker

To complete this section, you will need:

- 1 x RS Feva gennaker
- 1 x gennaker halyard block and shackle
- 1 x gennaker sheet
- 1 x gennaker downhaul bobble

HINT

Your RS Feva will arrive with the gennaker halyard and bowsprit already rigged. There is no need to unthread the halyard from under the foredeck when you are rigging the gennaker. Should the halyard be accidentally pulled through, please refer to Appendix 9.3 RS Feva Gennaker Pole System to re-rig.

Before stepping the mast you will need to complete the following steps:

a)

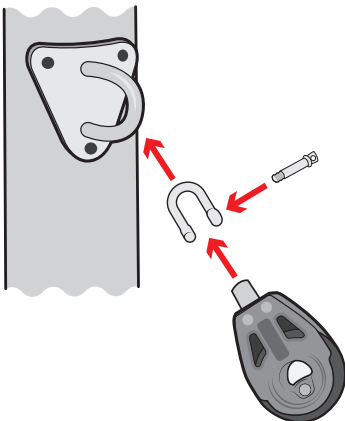

- Shackle the gennaker halyard block to the uppermost metal ring on the front face of the top mast.

b)

- Uncoil the gennaker halyard (that is emerging through a hole in the foredeck).
- Take the end of the gennaker halyard and, with the mast lying beside the boat, thread it through the gennaker halyard block.

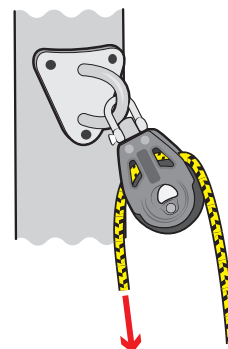

- Secure the gennaker halyard at the base of the mast.

Now step the mast, following the instructions in Section 3.5 - Stepping the Mast.

RS
Fera 3.6 - Stepping the Mast

- b)
- Lay the mast along the boat with the mast foot in the mast well.

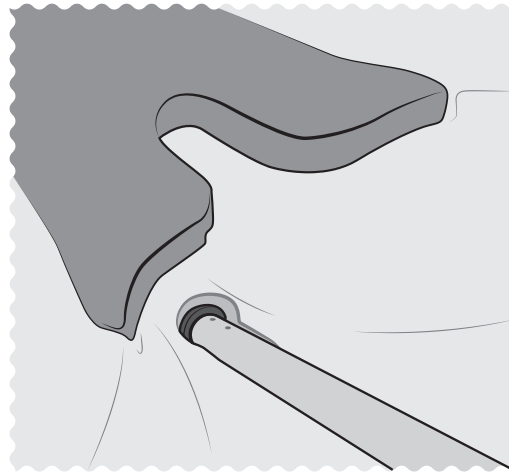

- c)
- Stand the mast up. The mast foot should slide down the mast well and sit comfortably in the mast cup. The lip on the lower mast collar should be under the foredeck, to enable you to close the mast gate.
 - Close the mast gate, ensuring that you have not trapped any ropes in it.

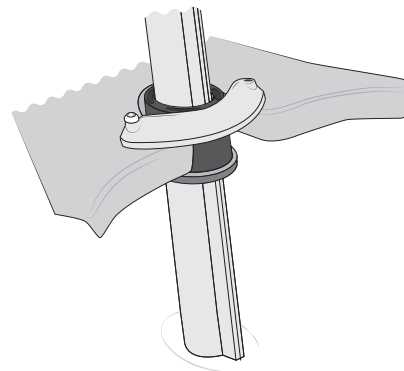

- d)
- Push the mast-gate pin back into the hole, add the knurled nut and tighten.

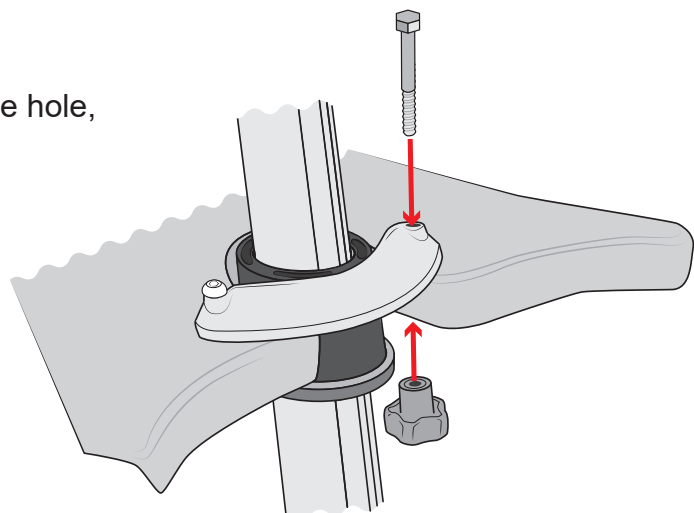

To rig the **kicker**, you will need:

- x2 20mm blocks
 - x1 Single Jam Block and Becket
 - Kicker cascade rope - 4mm Evo Performance - 2300mm
- Take the cascade rope and mark where it will attach to the single jam block with becket (see diagram below).
 - Tie the cascade rope onto the jam block using **knot #6**
 - Thread the long end through one of the 20mm blocks and then back through the jam cleat block and through the jammer.
 - Thread the short end through the other 20mm block and tie it onto the first 20mm block using **knot #1**
 - Tie **knot 3** in the end of the line

The standard **kicker** will come as standard with the boat, if you have the Race pack, refer to the instructions included within to rig the race **kicker**.

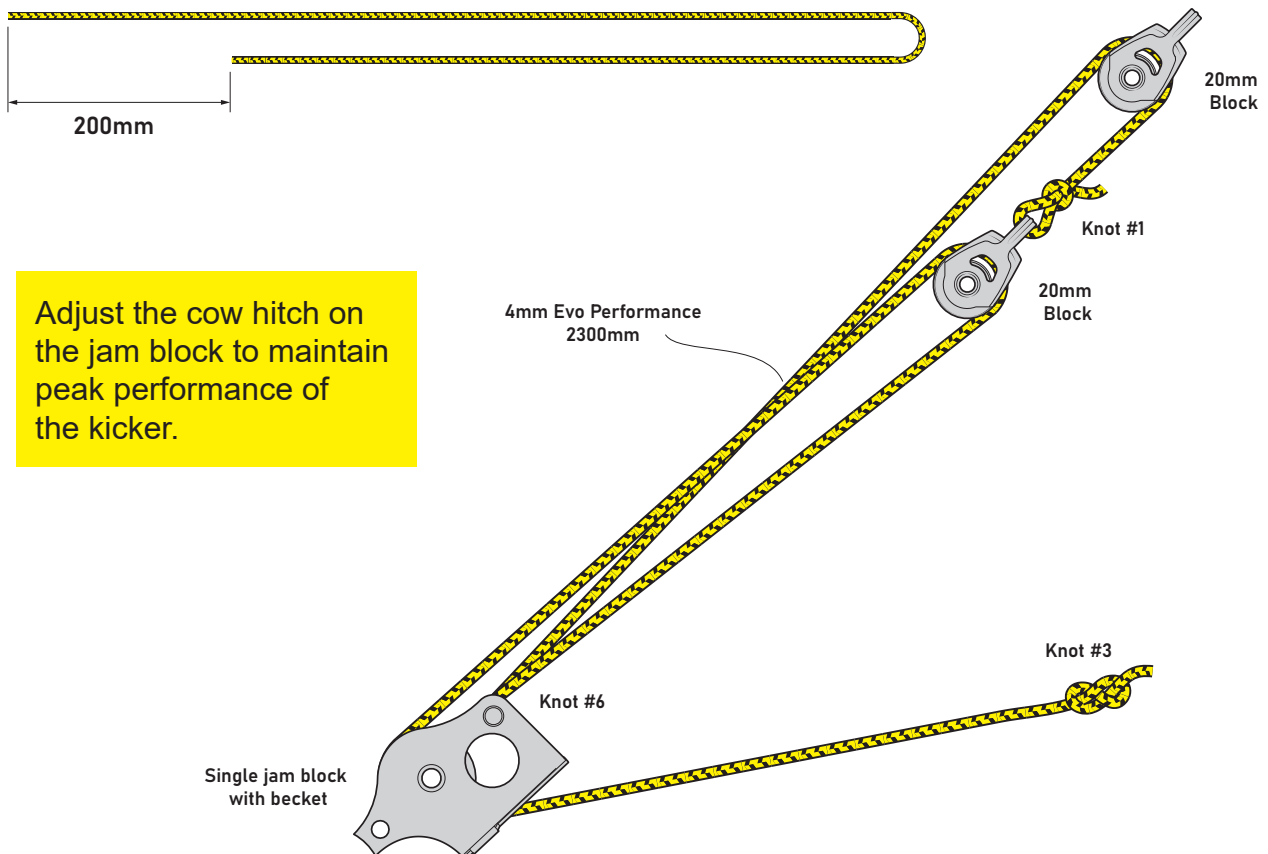

RS
Feva 3.8 - Rigging the Boom

To rig the boom, you will need:

- The boom
- The kicking cascade
- The kicker boom strop

The standard outhaul will come rigged on the boom, if you have the Race pack, refer to the instructions included within to rig the race outhaul.

- a)
- Take the kicker boom strop and tie knot #3 in one end.
 - Thread the other end through the small metal eyelet on the top of the boom, about 50 cm from the front end.

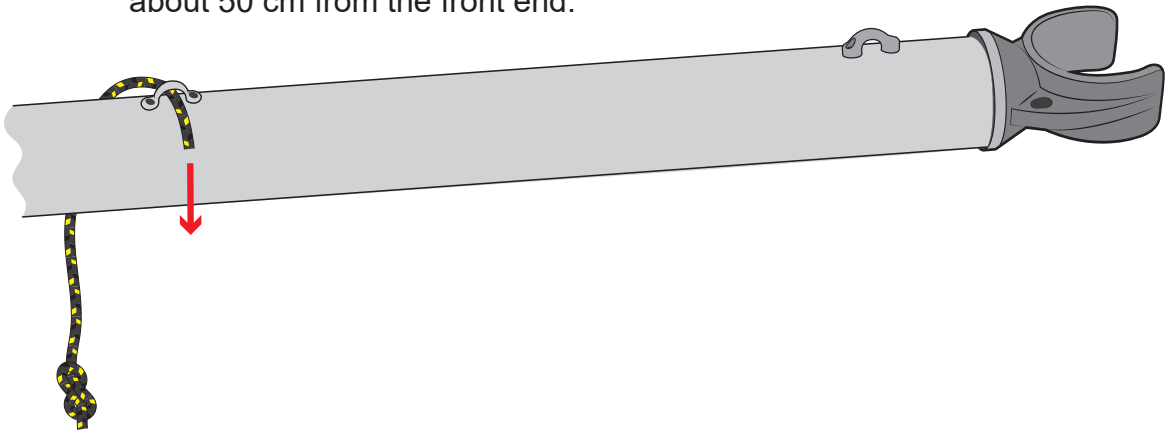

- b)
- Thread the end through the metal loop on the top block of the kicking cascade.

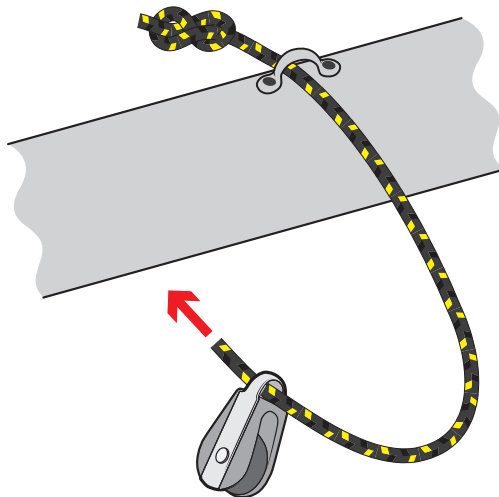

c)

- Finally, thread the end back through the eyelet on the boom, in the opposite direction to the other end, and tie **knot #3** in the end

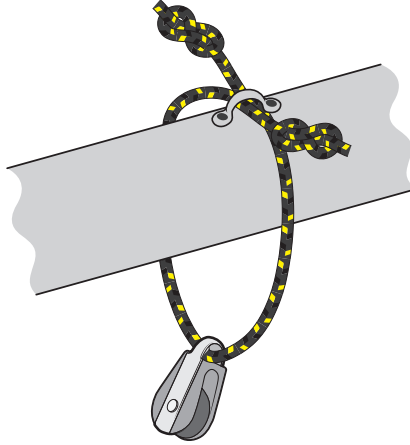

To complete this section, you will need:

- The daggerboard
- Daggerboard retaining elastic
- Daggerboard retaining clip

a)

- Thread one end of the daggerboard retaining elastic through the daggerboard handle, and tie a figure of eight.

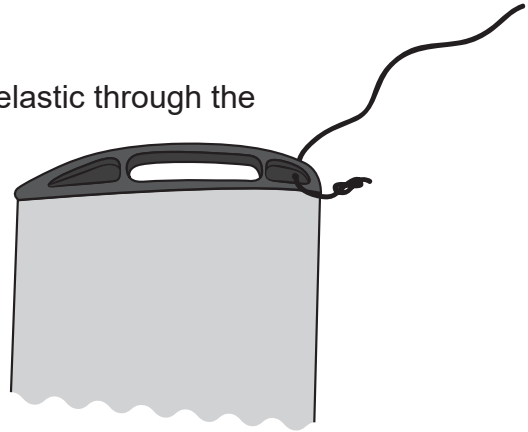

b)

- Tie the daggerboard retaining clip on to the other end of the daggerboard retaining elastic using a **knot #1**.

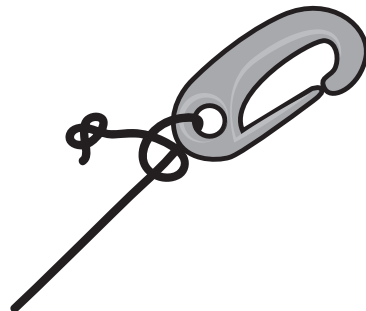
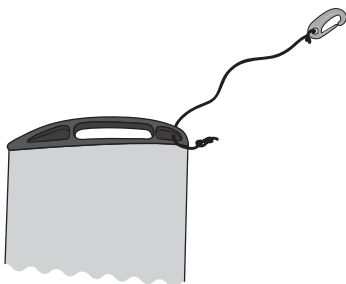

RS
Feva 3.10 - The Rudder

To complete this section, you will require:

- The rudder
- The rudder **stock**
- The **Tiller**
- The **Tiller** retaining screw
- The **Tiller** extension

- a)
- Remove the rudder assembly from the foil pack and locate the components. The self-tapping screw is in a small bag, in with the **tiller** arm.
 - Slide the **Tiller** into the **stock** and fix it with the self-tapping screw.

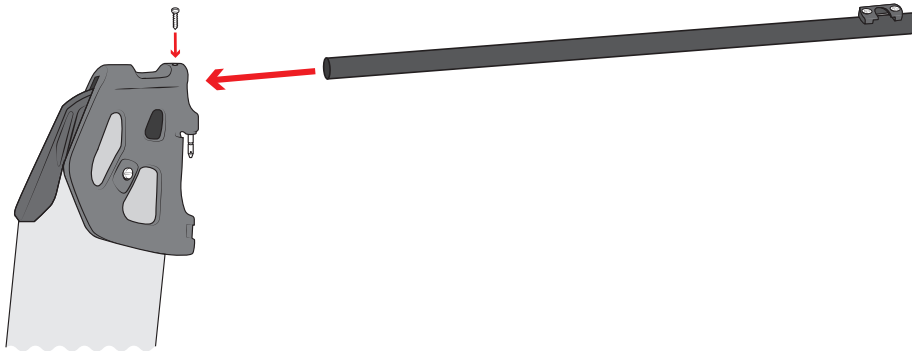

- b)
- Tie a **20mm downhaul block** onto the rope from the Rudder blade



- c)
- Attach the **tiller** extension to the **tiller**.

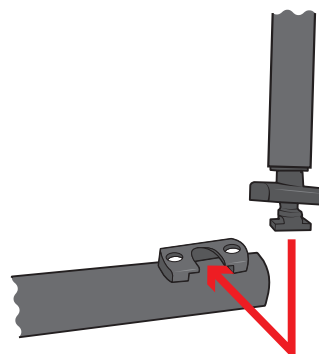

RS
Feva 3.11 - Hoisting the **Mainsail**

To complete this section, you will need:

- The **mainsail** (either the Feva S reefing **mainsail**, or the Feva XL 3-batten **mainsail**)
- The **kick field clip**
- The **mainsheet**

- a) • Take the **mainsheet** and thread one end through the large **block** in the centre of the boat.

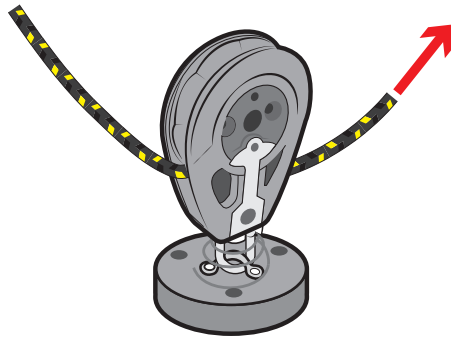

- b) • Next, thread the **mainsheet** through the **block** in the middle of the **boom**, leading it towards the back of the boat.

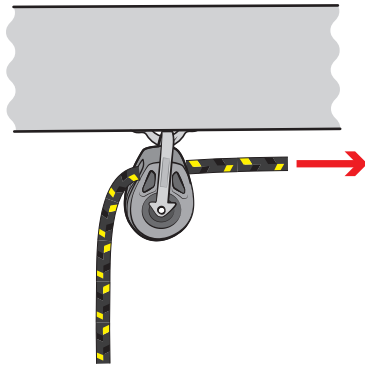

c)

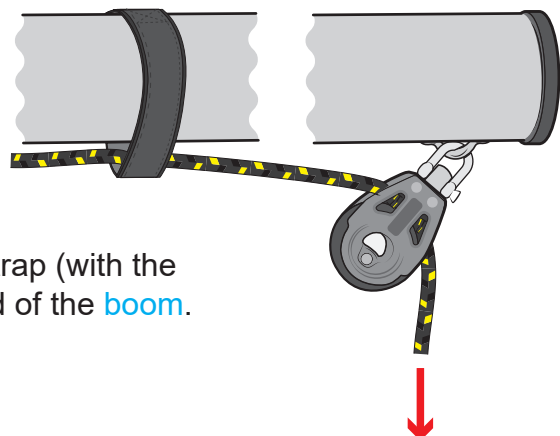

- Thread the **mainsheet** through the webbing strap (with the **outhaul**), and through the **block** at the back end of the **boom**.

d)

- Thread the **mainsheet** through the **block** on the **mainsheet** bridle.

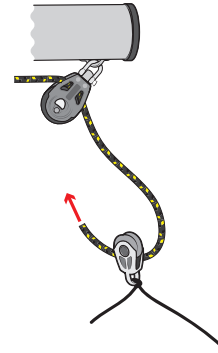

d)

- Lead the **mainsheet** back up to the end of the **boom**, and thread it through the hole in the center of the **block** on the **boom**. Tie a **knot #4** in the end of the **mainsheet**.

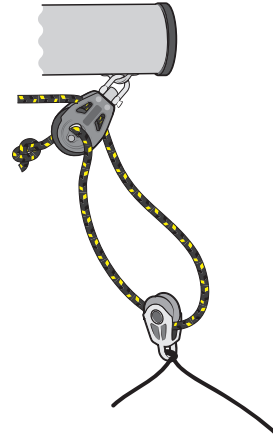

e)

- Unroll the **mainsail**.
- Take the end of the **main halyard** that comes down the **mast** from the bullseye (not from the **cleat**), and tie it to the top of the **mainsail** using **knot #1**.

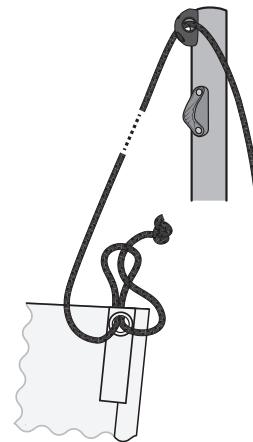

f)

- Put the top of the **mainsail** into the opening at the bottom of the **mast track**, just above the **gooseneck mast collar**.
- Holding the sail in line with the **mast**, pull on the other end of the **main halyard**.
- Pull the **mainsail** up to the top of the **mast**. To make hoisting the **mainsail** easier, keep it in line with the **mast**, especially when passing the batten pockets.

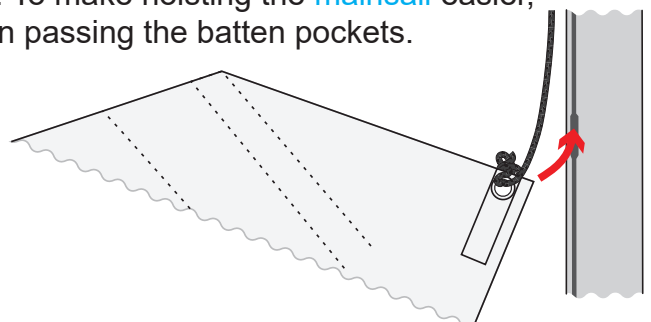

- g)
- When the mainsail is at the top of the mast, lead the halyard tail that you have been pulling around the outside of the shroud, and pull it forward.
 - Pull the halyard towards the back of the boat, until it locks in the cleat at the top of the mast.

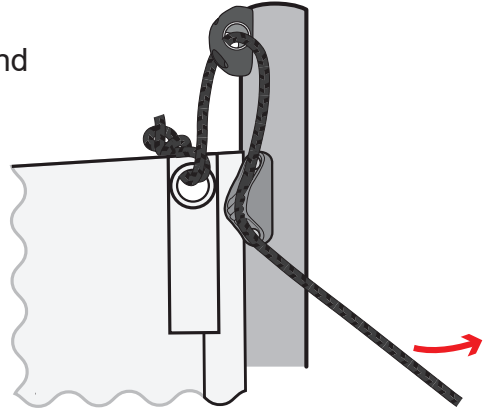

- Once the halyard is cleated, bring it back around the shroud.

- h)
- Take the Englefield Clip and thread the end of the halyard through the hole.



- i)
- Clip the Englefield Clip on to the one attached to the elastic by the mast gate.

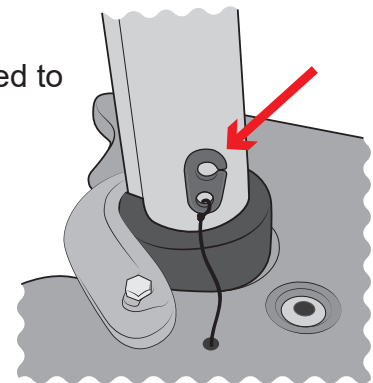
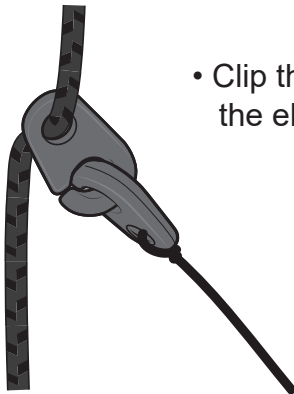

- j)
- Pull the halyard through the Englefield Clip until all the slack has been taken up.
 - Tie knot #3 here to keep the clip in place.

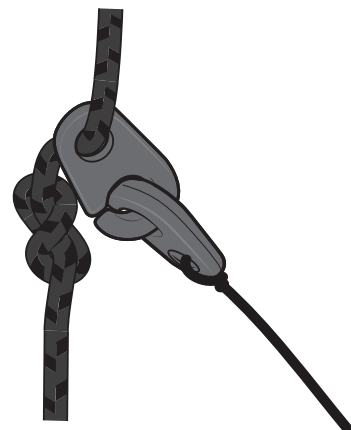

The **Englefield Clips** stop the **halyard** flopping around when the **mainsail** is hoisted. To lower the **mainsail**, release the Kicker, **outhaul** and **downhaul** and unclip the two clips, pull the **halyard** out of the **cleat** at the top of the **mast**, and pull the **mainsail** down.

- k)
- Coil up the **halyard** and stow it in the **halyard** bag.

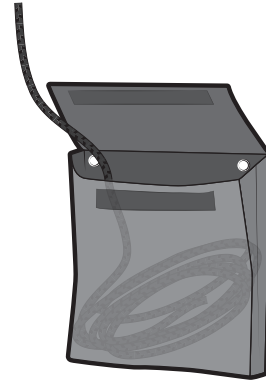

- l)
- Push the gooseneck onto the **gooseneck mast collar**.

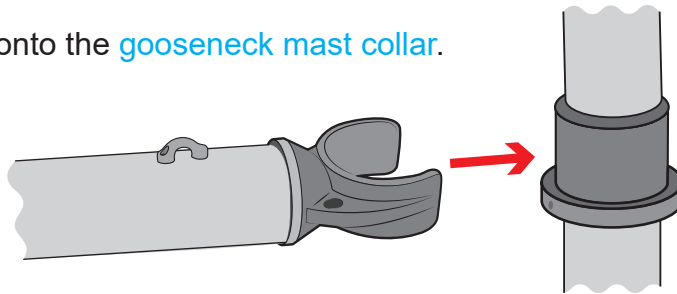

- m)
- Hook the clew of the sail onto the hook at the end of the **boom**. You may like to use the black webbing strip on the clew as a handle to pull the sail into position, making it easier to hook the **mainsail** clew hook onto the sail.

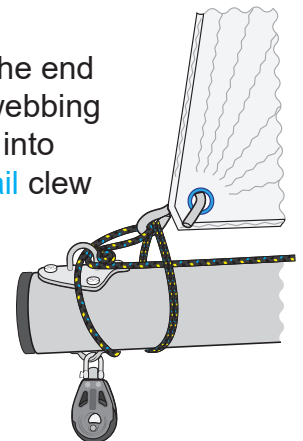
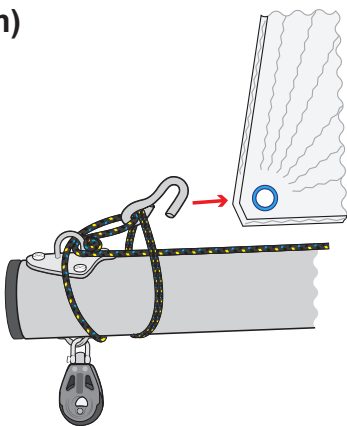

- n)
- Take the **downhaul** rope and tie a large **knot #3** in one end.



RS
Feva 3.11 - Hoisting the **Mainsail**

o)

Thread the other end of the **downhaul** up through the **gooseneck mast collar**, on the **port-hand side** of the **mast**.

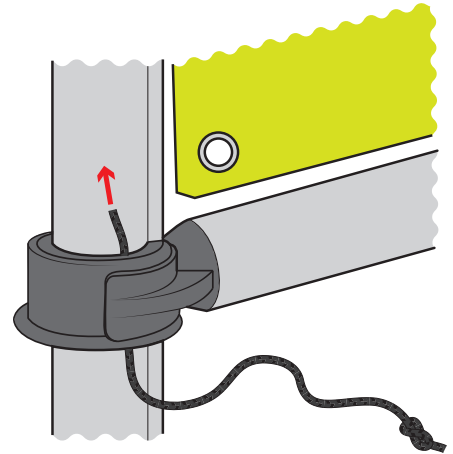

p)

• Pass the end of the **downhaul** through the bottom eyelet in the tack of the **mainsail**, and through the **cleat** on the **starboard side** of the **mast**.

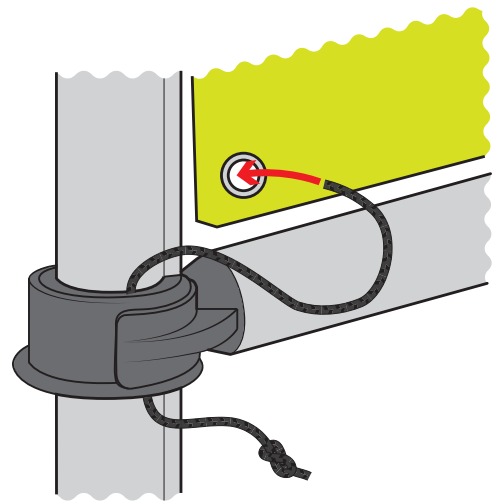

q)

• Connect the **cleat** on the **kicking cascade** to the **Shackle** on the **mast**.

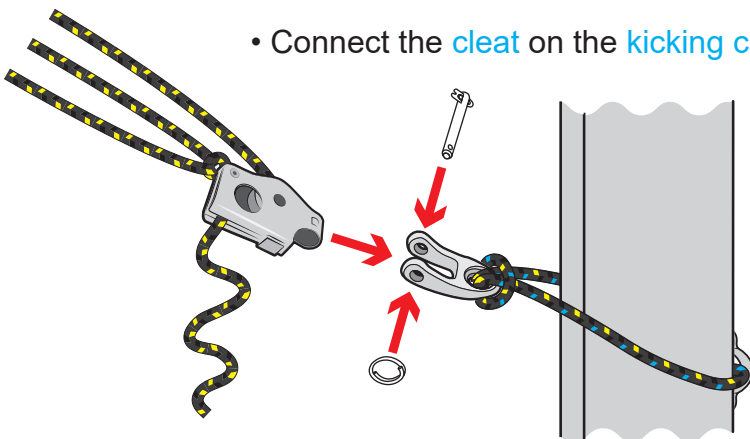

If you are not fitting the **jib** or the **gennaker**, move straight on to Section 3.11 – Completion.

Now step the mast, following the instructions in Section 3.5 - Stepping the Mast.

Once the mast is stepped in the boat, you should attach the **shrouds** to the **shroud** adjuster plates. A good setting to start with is with the pin in the third hole down on the **shroud** adjuster plate.

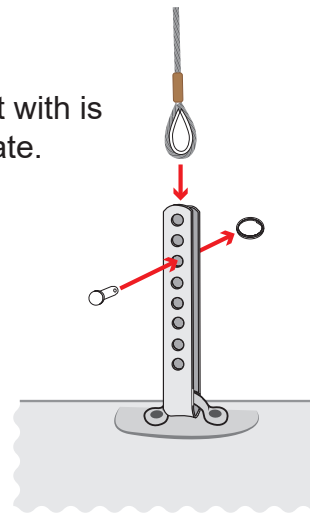

HINT

The mast on the RS Feva is supported at deck level by the **mast gate** and the foredeck. The **shrouds** are fitted to stop the mast from bending when tension is applied to the **jib halyard**, hence making the **jib** work better. Therefore, changing the **shroud** adjuster hole position will affect the amount that the mast bends when tension is applied to the **jib halyard**.

RS Feva 3.12 - Hoisting the Jib

i)

- Unroll the **jib**.
- Take the tail of rope sewn into the tack of the **jib**, and pass it through the metal loop on the tack bar.

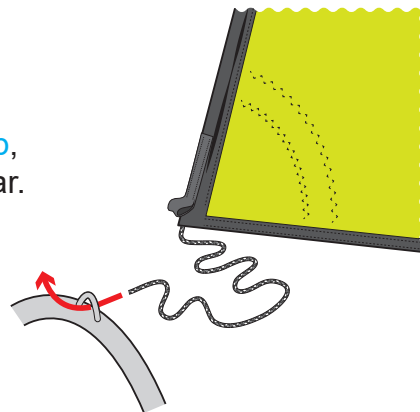

j)

- Pass the tail through the webbing loop sewn onto the tack of the **jib**.

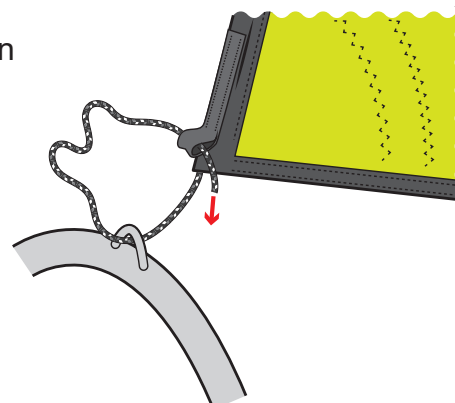

k)

- Pull the rope taut, and tie it off using two or three half hitches.

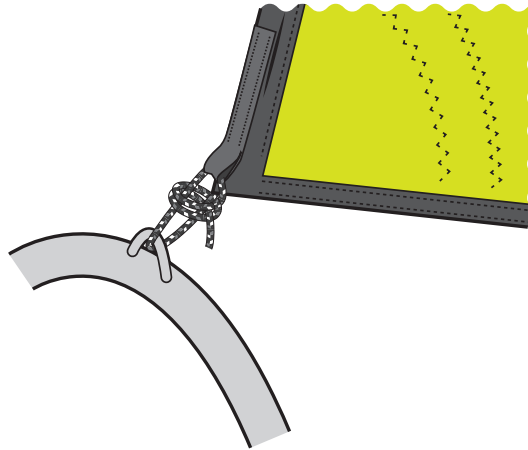

l)

- Tie one end of the **jib halyard** onto the loop of rope sewn into the head of the **jib**, using **knot #1**

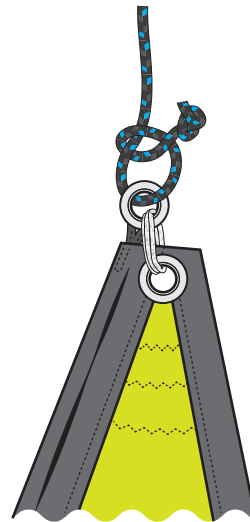

Note: Instead of a rope loop, the RS Feva Race **Jib** has a metal eye at the head. Tie the **jib halyard** to this in the same way.

m)

- Pull the **jib** up and tie the **halyard** off around the horn **cleat** on the side of the mast. Only apply enough **halyard** tension to prevent the front of the **jib** from sagging whilst sailing.

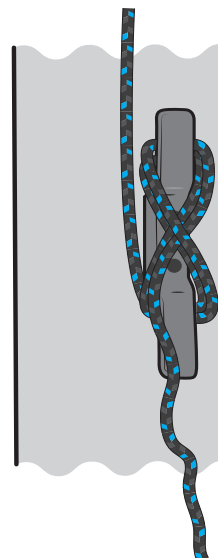

n)

To attach the jib sheet, either:

- Thread the jib sheet through the middle of the three holes on the clew plate.
- Pull the sheet through until there is an equal amount either side of the sail.
- Tie a figure-of-eight knot in the jib sheet on either side of the clew plate

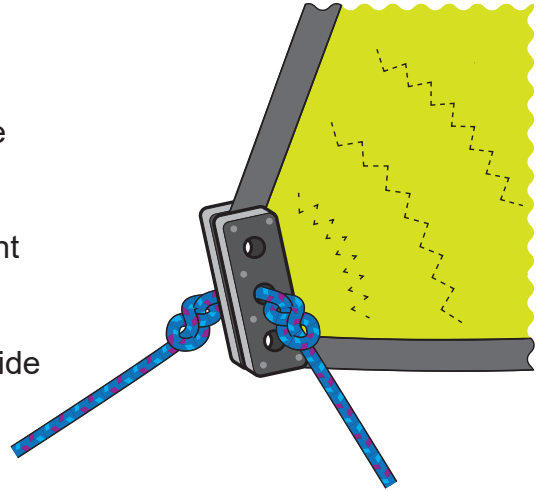

OR

- Find the centre of the jib sheet by folding it in half.
- Take the flat stainless-steel shackle from the Jib Pack, and attach the jib sheet to it.
- Attach the shackle to the jib clew plate.

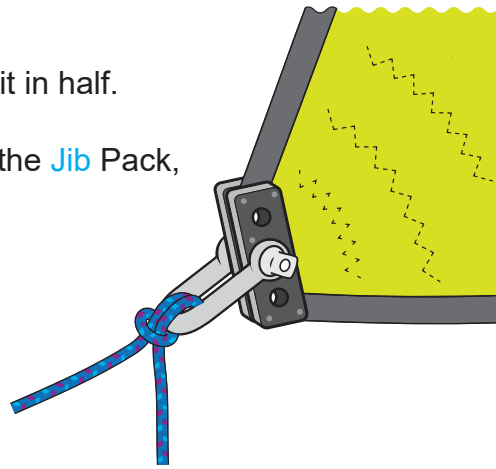

o)

- Take one of the jib sheet ends and pass it through the bullseye and jib cleat, mounted just inboard of the shrouds.

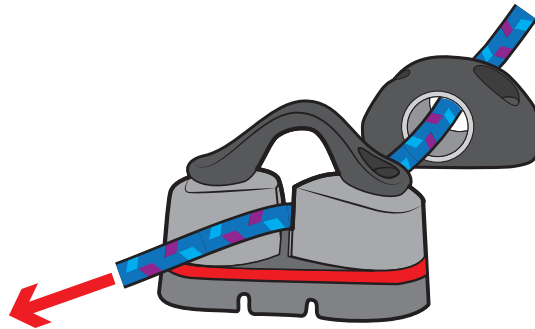

- Do the same with the other side, and then tie the two ends together.

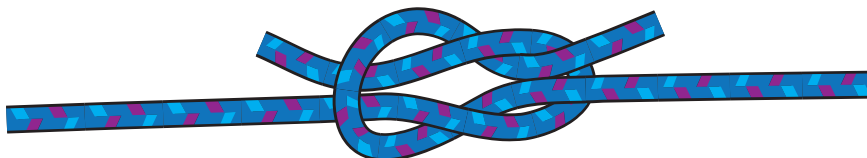

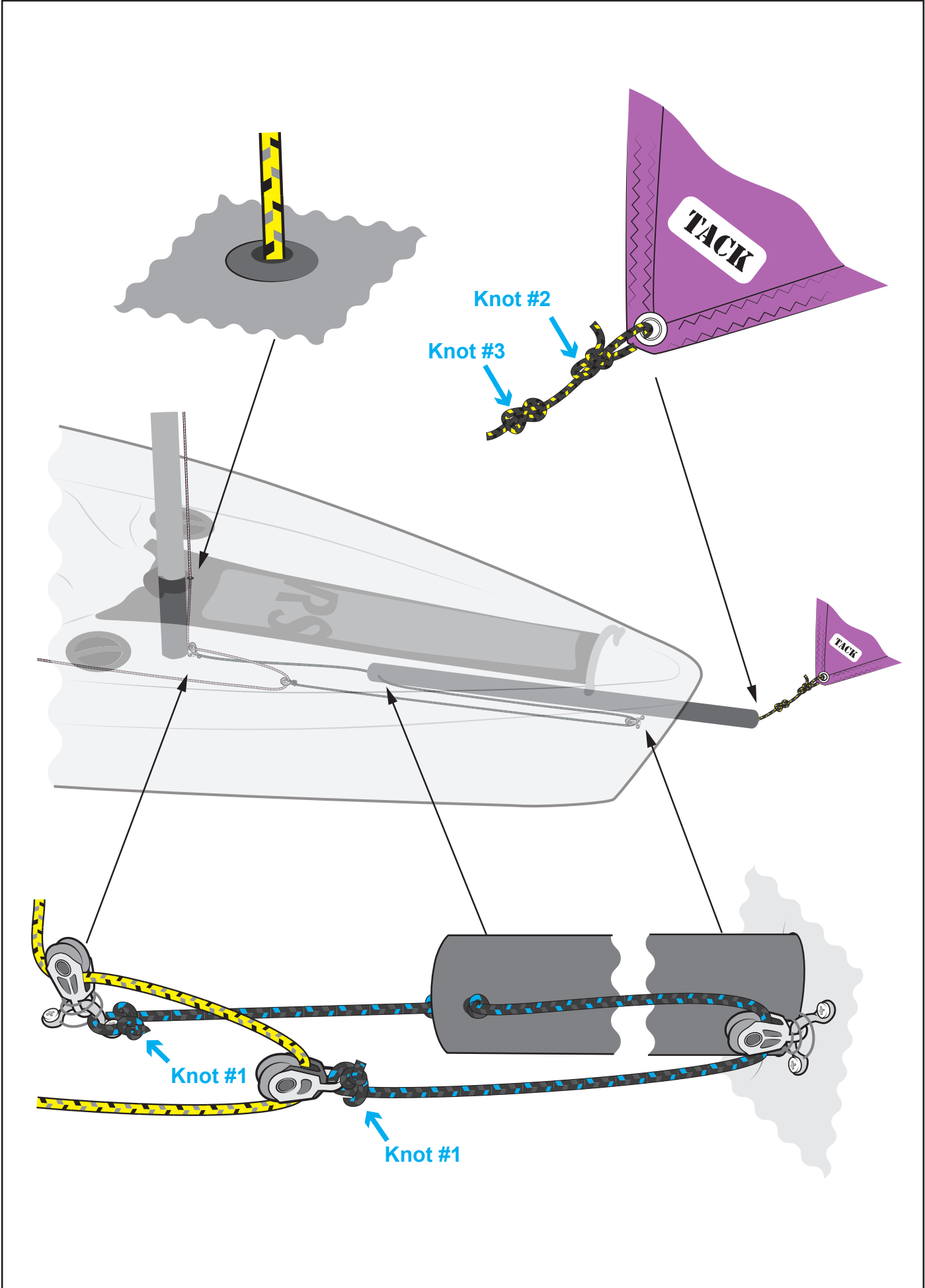

TOP TIP

Make sure that the **gennaker halyard** and the **downhaul** line are on opposite sides of the mast.

- c) • Unroll the **gennaker**.

- Take the tack line that emerges from the end of the bowsprit and tie it to the tack of the **gennaker**, using **knot #2**. The knot that is already in the tack line needs to be left in place, as it determines how far the bowsprit comes out when the **gennaker** is hoisted.

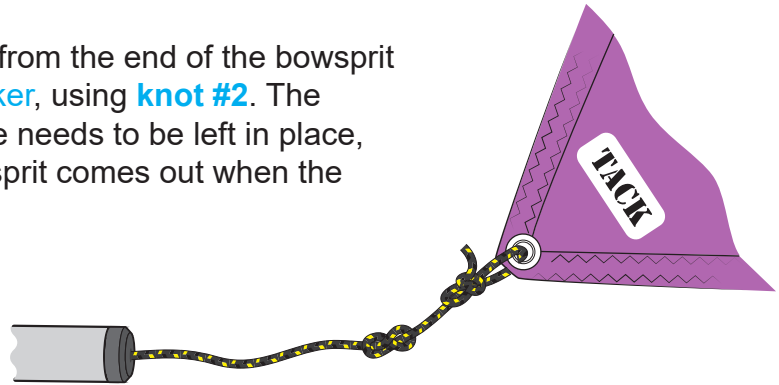

- d)

- Tie the end of the **gennaker halyard** to the head of the **gennaker**, using **knot #2**.

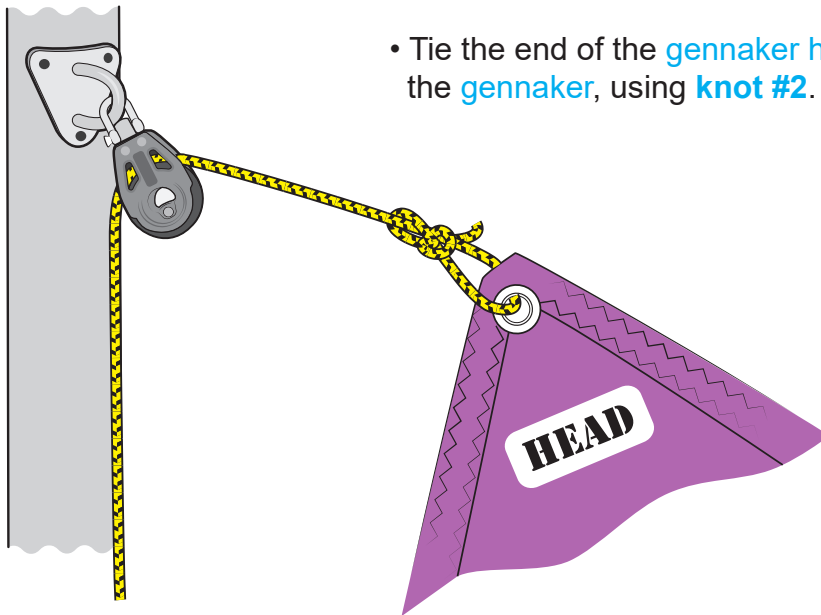

- e)

The **gennaker downhaul** line (the other end of the **gennaker halyard**) is already rigged. It is running through the **gennaker** chute, and is tied to the tack bar.

- Untie the **gennaker downhaul** line, taking care not to let go of it, as it will disappear up the **gennaker** chute!

- f)
- With the gennaker on the port-hand side of the boat, pass the end of the gennaker downhaul through the small eyelet in the centre of the gennaker, from the inside to outside.

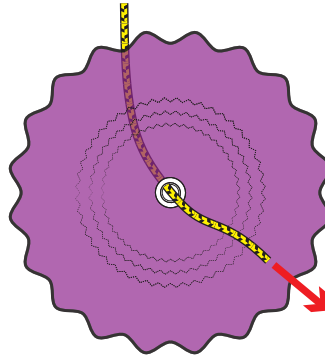

- g)
- Run the gennaker downhaul line up the outside of the gennaker.
 - Take the gennaker downhaul bobble from the customer pack and thread the downhaul through it. Place the gennaker downhaul bobble approximately 200 mm from the end of the downhaul, and tie it in place with a single overhand knot.
 - Tie the end of the gennaker downhaul onto the upper patch (cross of webbing) using knot #2. If you find that the gennaker does not come all the way down, shorten the distance between the bobble and the patch.

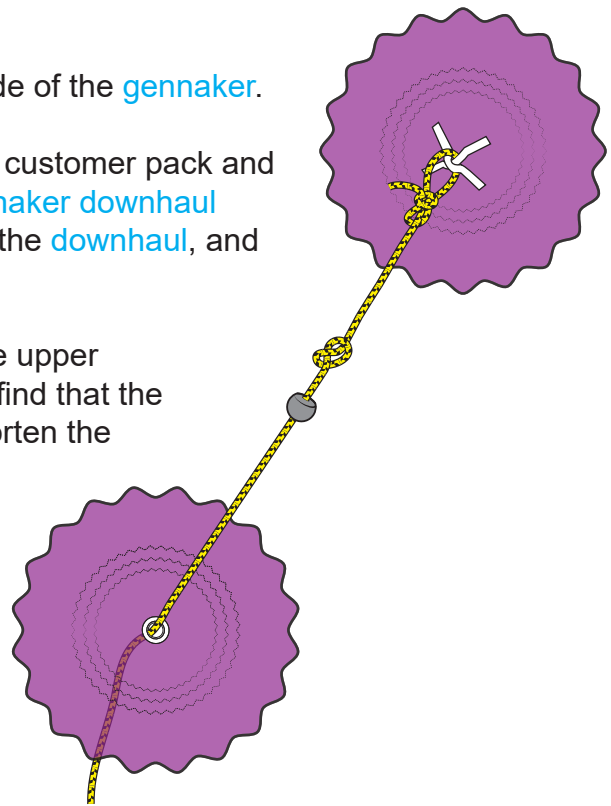

- g)
- Find the middle of the gennaker sheet and double it over to form a loop.
 - Pass this loop through the eyelet at the clew of the gennaker.
 - Pass the tails of the gennaker sheet through the loop and pull it tight.

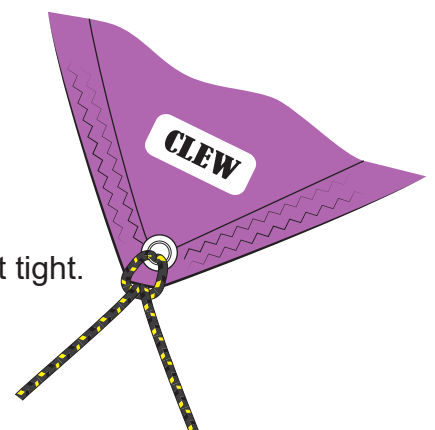

RS
Feva 3.13 - Rigging the Gennaker

h)

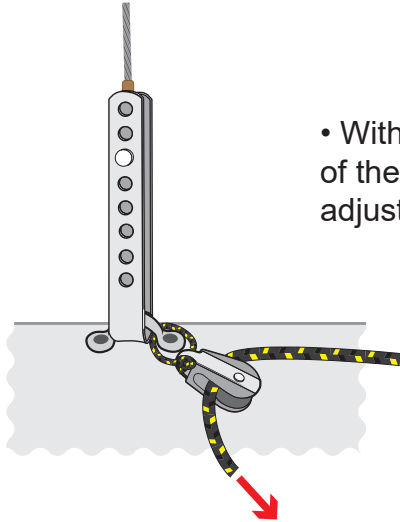

- With the gennaker on the port side of the boat, thread one end of the gennaker sheet through the block by the port-side shroud adjuster plate.

i)

- Take the other end of the gennaker sheet, pass it around the front of the jib, and into the block on the other side.

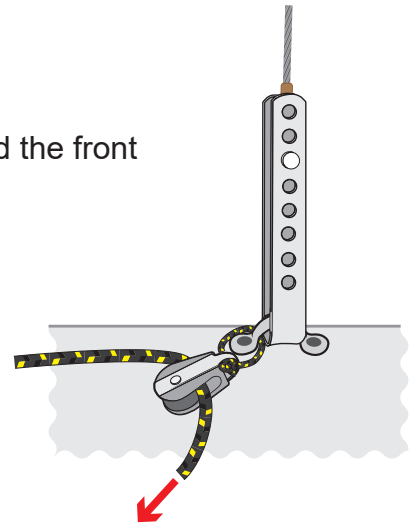

i)

- Tie the two ends of the gennaker sheet together.



j)

- Pull the gennaker from one side to the other, as if you were gybing, to see if anything is twisted.
- Finally, pull the gennaker down into the gennaker chute.

Now you are almost ready to go Feva sailing. All that is left to do is:

- Fit the rudder to the back of the boat
- Tidy the **halyards** away
- Check that all knots and shackles are tied securely

a)

- To fit the rudder, simply line up the pins with the fitting on the back of the boat and push down until the retaining clip 'clicks' into place.

The rudder may be difficult to get on at first – all it will need is a simple wiggle from side to side whilst pushing down.

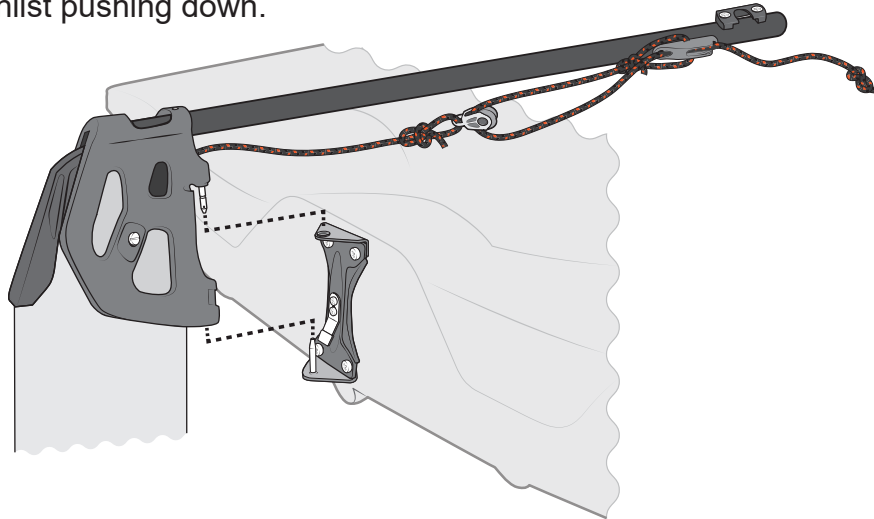

- To remove the rudder, simply push the retaining clip in and pull the **stock** up.

b)

- Coil the main and **jib halyards** neatly and stow them in the **halyard** bag.

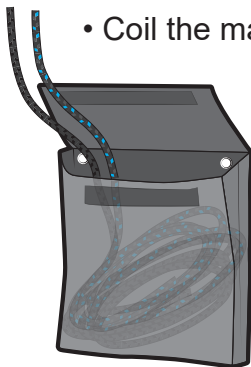

TIME TO GO SAILING!

RS *Feva*

Rigging Guide

4. Sailing Hints



PLEASE FOLLOW RIGGING GUIDE IN CORRECT ORDER

RS
Feva

RS *Feva* 4.1 - Introduction

The RS Feva is a very rewarding boat to sail – to fully appreciate its handling, you should be comfortable with the basic techniques of sailing small boats. If you lack confidence or feel that a refresher is in order, there are many approved sailing schools which use the RS Feva. See www.rya.org.uk for more information, or follow the link from www.rssailing.com to find your local RS Academy.

While we offer you a few hints to aid your enjoyment of your new boat, they should not be considered as a substitute for an approved course in dinghy sailing. In order to build your confidence and familiarise yourself with your new boat, we recommend that you choose a fairly quiet day with a steady wind for your first outing.

RS *Feva* 4.2 - Launching

With the sails fully hoisted, attach the rudder to the transom. Lead the **daggerboard** retaining elastic around the mast and clip it back on itself. Leave this in place while sailing. The boat should be wheeled into the water, keeping it head to wind as far as possible.

If you have a crew, he/she can hold the boat head to wind whilst the trolley is stowed ashore.

If the tide is coming in as you launch, make sure that you leave the trolley far enough up the beach that it will not be swept away.

RS *Feva* 4.3 - Leaving the Beach

The easiest way to get going is for the helm to hop aboard while the crew holds the boat. The helm should put a little **daggerboard** down, with the shockcord with the plastic-tubing cover pulled forward, then move back to his normal position, and pull gently on the rudder **downhaul** to lower some of the rudder blade. Then, s/he may instruct the crew to push the bow off the wind and climb in. The crew will then lower the **daggerboard** as depth allows. The shockcord acts as a friction device and a retainer when the board is fully down. Thus, as soon as the Water is deep enough, the **daggerboard** should be fully lowered, and the shockcord pulled back over the top of the board, so that it is secure in the event of a fully inverted capsize.

The singlehanded sailor may choose to ask someone to help them to launch. If launching alone, stand in the water alongside the gunwhale, holding the boat head to wind. Lower part of the **daggerboard** and rudder, and then push the bow off the wind while hopping in.

TOP TIP

If you are using the **jib, pulling this sail in as you leave the beach will ensure that the bow continues to swing away from the direction that the wind is blowing from.**

As soon the water is deep enough, make sure that you lower the rudder blade fully by pulling hard on the rudder **downhaul**. You will know it is fully down if you feel a gentle “thud” as the front face of the blade hits the front face of the **stock**. **Cleat** the **downhaul** and tidy it by winding it around the **tiller**. Pull the sail in and you are away!

For the best performance, you should ensure that you and your crew position yourselves so that the boat is sailing through the water as flat as possible.

Watch the trim (fore and aft) and the heel. The boat should always be sailed as upright as possible.

Top Tip

As a general rule, sit further forward in lighter winds and further aft in stronger breezes.

When sailing close-hauled, or as close as possible to the wind, it is **important** to get the **boom** as near as possible to the centreline, especially when sailing the RS Feva XL with the **mainsail** and **jib**. The kicking strap should be firmly tensioned for upwind work. To pull it on, quickly put the boat head to wind. You should hold the **tiller** extension across your body, with a knuckles-up grip, enabling you to use one or two fingers as a temporary **cleat** when adjusting the **mainsheet**.

The **jib sheet** should be pulled in fairly hard when sailing upwind – tighter in stronger winds and less so in lighter winds. Sail to the **jib** tell-tails, keeping the one on the back of the sail streaming and the one closest to you either streaming or lifting upwards slightly.

To tack, push the **tiller** extension away from you and, as the boat starts to turn, step across the cockpit facing forwards. Once the boat has completed the turn, bring the **tiller** back into the centre before sitting down on the new side, with the **tiller** extension behind your back. When you are settled, swap the **mainsheet** and the **tiller** extension into the new hands.

HINT

When sailing single-handed, sit with a leg either side of the thwart area when sailing close-hauled or reaching. If there is a lull in the wind, simply slide your backside down off the gunwhale and onto the thwart.

If the boat slows right down and feels lifeless when close-hauled, you could be sailing too close to the wind. Ease the **mainsheet** and ‘bear off’ away from the wind for a while to get the boat going again.

RS Feva 4.5 - Sailing Downwind and Gybing

When sailing downwind, both sails should be let out as far as possible. Single-handed sailors should adopt a relaxing, reclined pose astride the thwart area, leaning back against the side deck. To gybe, pull the **tiller** towards you and, as the boat starts to turn, step across the cockpit facing forward. Once the boat has completed the turn, bring the **tiller** back into the centre before sitting down on the new side, with the **tiller** extension behind your back. Often, the **boom** will not want to come across until you have nearly completed the gybe, so it often pays to give the **mainsheet** a tweak to encourage the **boom** over at the moment that you want it to come! Once you are settled, swap the **mainsheet** and the **tiller** extension into the new hands.

Top Tip

Be aware that the **boom** can come across with some force during a gybe (intentional or not!) so mind your head and watch for unintentional gybes.

RS Feva 4.6 - Using the Gennaker

If you are inexperienced in using a **gennaker**, choose a fairly quiet day for your first excursion. A **gennaker** nearly doubles your sail area, and should be treated with a healthy degree of respect!

For your first hoist you should be sailing downwind on a broad reach, with the wind coming over the helm's left shoulder. The crew should sit in the centre of the boat, astride the **daggerboard** case, and hoist the **gennaker** by pulling the **gennaker halyard** from the right-hand **halyard block**.

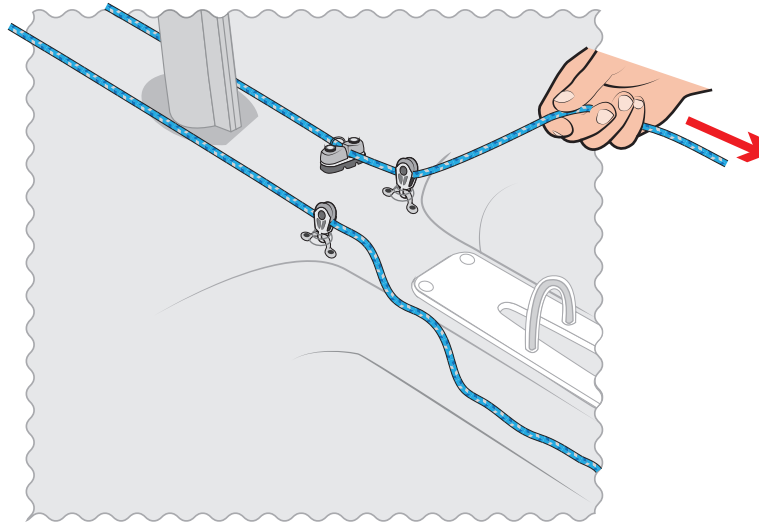

The **gennaker halyard** pulls the bowsprit out at the same time – when the **gennaker** is hoisted, you are ready to go. The crew, or the helm if sailing singlehanded, should now pull gently on the leeward **gennaker** sheet until the **gennaker** has filled. **Gennakers** may be effectively used from a close reach to a broad reach so, to get downwind, one should become adept at gybing. It is not possible to tack with the **gennaker** hoisted. For the best effect, the **gennaker** sheet should always be eased as far as possible, so that the luff is just on the point of curling.

Gybing with the **gennaker** is fairly straightforward. Like the **jib**, it should be pulled across at the same time as the **mainsail** comes across. As soon as it has been pulled in and filled with wind, it should again be immediately eased for maximum efficiency and speed. If sailing singlehanded, the **mainsheet** should be trapped between the fingers and **tiller** extension, and the helm should hold the **gennaker** sheet at all times.

To drop the **gennaker**, reverse the procedure used to hoist. The boat should be sailing on a broad reach, and the slack in the **gennaker downhaul** is pulled in from the left hand **halyard block**.

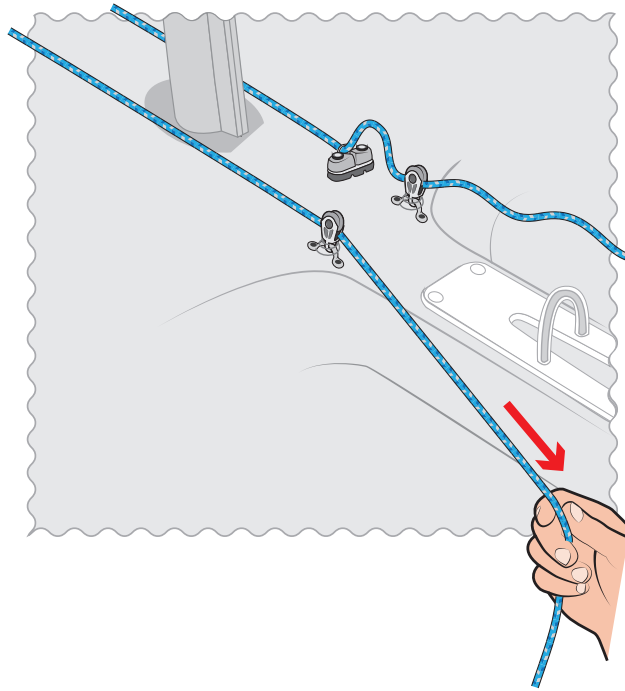

As the **gennaker downhaul** goes tight, the **gennaker halyard** should be popped out of the **cleat**. Then, pull the remainder of the **gennaker downhaul** through until the **gennaker** is pulled sharply into the chute. Dropping the **gennaker** on tighter reaches is harder, and requires more effort on the **gennaker downhaul**. If possible, this should be avoided when sailing singlehanded.

HINT

The **gennaker** can “bunch up” when entering the chute. This can be minimised by keeping some tension on the **gennaker** sheet, preventing the clew from being sucked into the chute with the main body of the **gennaker**.

When the **gennaker** is fully lowered, tidy the sheets and the **halyard** to keep the cockpit area clear.

Reefing reduces the sail area, and is an effective and essential way to continue sailing in winds that would otherwise keep the less experienced or younger sailors ashore. There are two ways to reef a RS Feva S **mainsail**:

HINT

The **jib** is very effective in strong winds because the majority of its area is low down so it helps with balance. Try slab reefing first – it's more fun for the crew!

Round-Mast Furling

This method of reefing is applicable to the RS Feva S **mainsail**, when sailed without a **jib**.

- a) • Detach the clew of the sail from the clew hook.

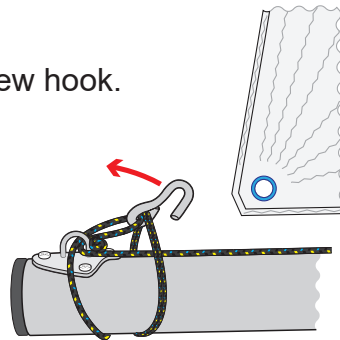

- b) • Detach the **kicking cascade** from the mast.

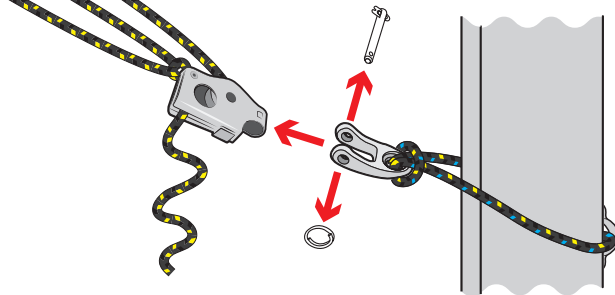

- c) • Using a firm two-handed grip, rotate the mast through three complete turns. This is normally enough to provide a significant reduction in sail area.

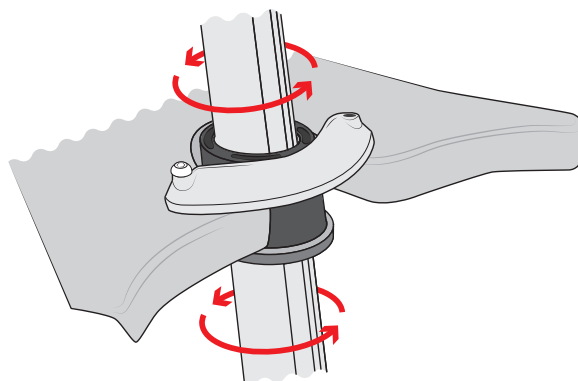

d)

- Re-attach the clew of the **mainsail** to the clew **outhaul** hook, and re-tension the **outhaul**.

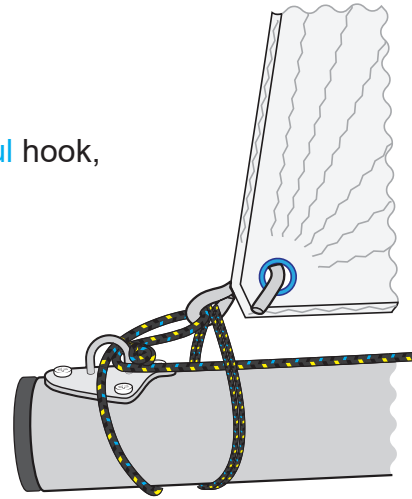

e)

- Re-attach the **kicking cascade** and tension to suit. The number of turns of the **mast** will determine the degree to which you reduce the power in the rig.

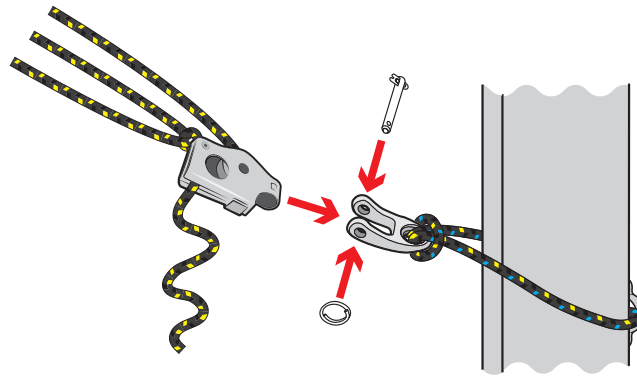

Slab Reefing

This method of reefing is applicable to the RS Feva S **mainsail**, when sailed with the **jib**.

a)

- Release the **downhaul** line out of the **cleat**.

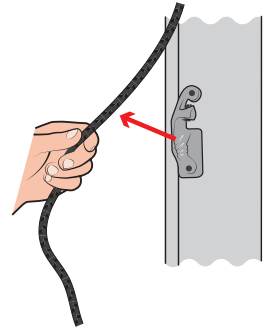

b)

- Ease the **kicking cascade**.

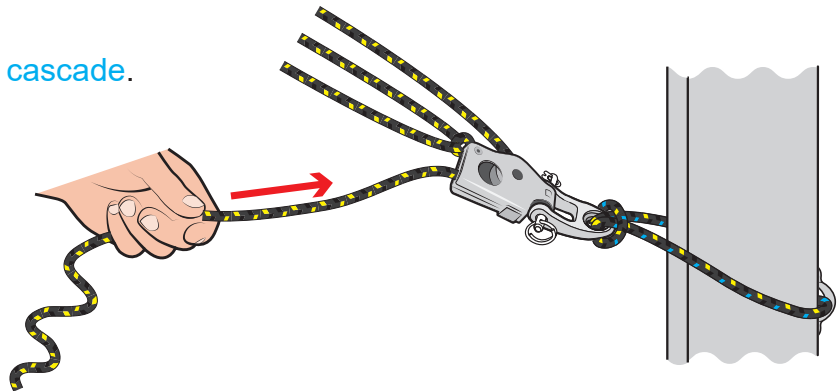

c)

- Ease the **main halyard** about 7 centimetres.

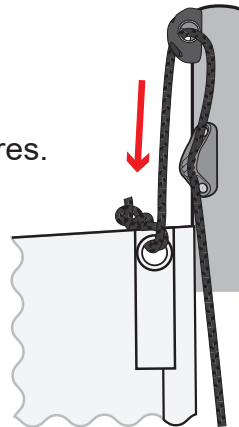

d)

- Pull the **mainsail** down until the line of reefing eyes in the sail are level with the **boom**.

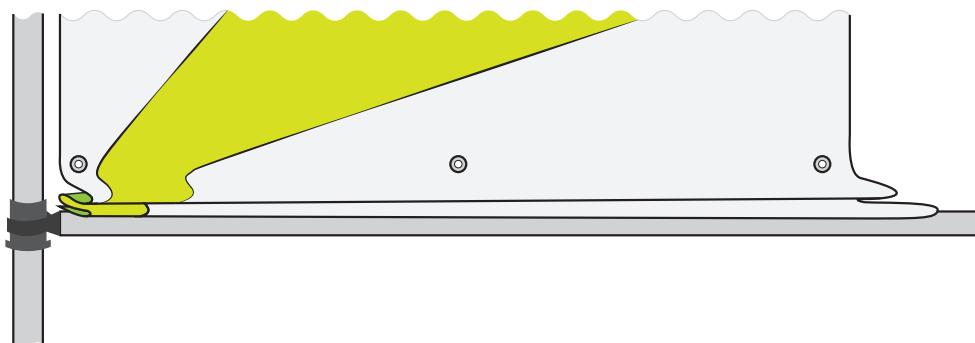

e)

- Roll up the excess **mainsail** and tie it to the **boom**. We recommend using a loop of elastic attached to a plastic hook.

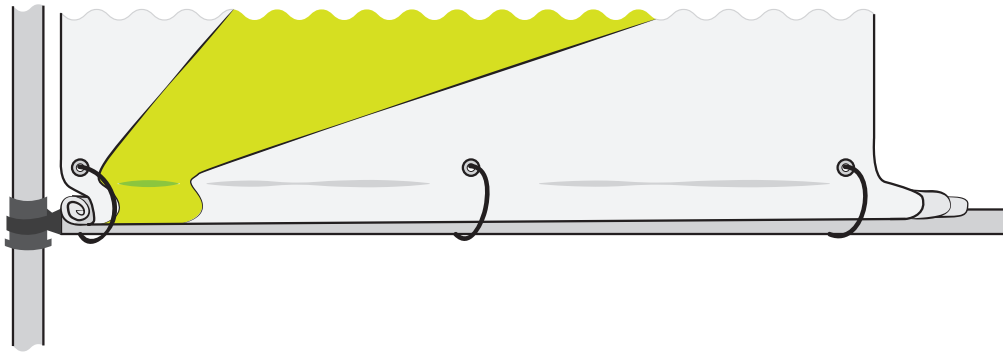

f)

- Re-apply tension to the **main halyard**, as required.

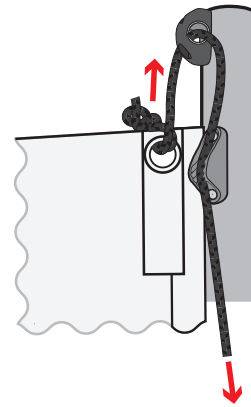

g)

- Re-apply tension to the **kicking cascade**.

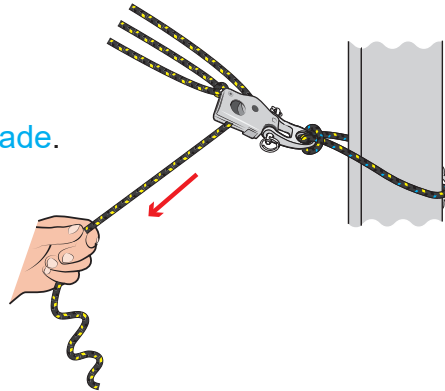

g)

- Re-thread the **mainsail downhaul** line, and **cleat** it on the **mast**.

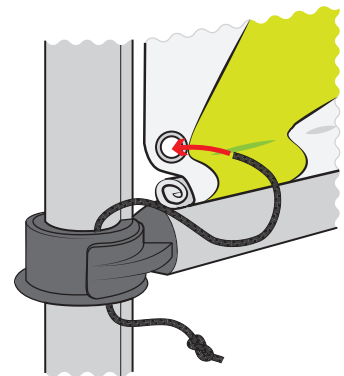

Sailing in strong winds can be great fun, so become familiar with the reefing systems and get back out there!

RS *Feva*

Rigging Guide

5. Maintenance



PLEASE FOLLOW RIGGING GUIDE IN CORRECT ORDER

RS
Feva

The RS Feva is made using Comptec PE3, a three-layer polyethylene construction. This is stiff and light, but will dent if subjected to point loading. The boat should be supported ashore on an approved RS trolley, as the hull may distort if not supported properly. For long-term storage, it is better to support the boat on a rack, in slings, or another type of support that spreads the weight and avoids point loads. The hull can also be stored on the transom, but never store the boat for long periods on its side. When dealing with a marine environment, equipment gets wet; this in itself is not a problem. The problem starts when moisture is trapped for any length of time. Therefore, it is very important to store the boat properly ashore.

Keep your dinghy drained and well ventilated

Ensure that the boat is stored with the bow raised to allow water to drain away.

Wash with fresh water

Fresh water evaporates far more quickly than salt water so if your dinghy has been sailed in salt water, rinse it thoroughly. The fittings will also work better if regularly washed. Any stubborn marks on the hull can be removed with a light detergent, such as washing up liquid. Always test cleaning products on a small, inconspicuous part of the deck before applying to the whole boat.

Hull damage falls into three categories:

- **SERIOUS** – large hole, split, crack, or worse. Don't be too distressed! Get the remnants back to RS Racing so we can assess the damage.
- **MEDIUM** – small hole or split. If this occurs during an event, sailing can often be continued as long as leaking can be prevented by drying the area and applying strong adhesive tape. CAUTION – if the damage is close to a heavily loaded point, then the surrounding area should be closely examined to ensure that it will accept the loads. Get the damage professionally repaired as soon as possible.
- **SMALL** – dents, scratching. This type of damage is not boat threatening.

Comptec PE3 cannot be repaired in the same way as fibre glass. Some scratching can be removed by RS Racing staff, but dents cannot. Therefore we suggest you treat your boat with as much care as you would if it were fibre glass. More serious repairs can be carried out by RS Racing staff; however, the repair will never be invisible, due to the nature of the material.

The joy of owning an RS Feva is that it is very hard wearing, and any dents and scratches it receives will not affect the structural integrity of the hull.

RS *Feva* 5.1 Foil Care

RS Sailing foils are manufactured from anodised Aluminium extrusions with injection moulded glass reinforced Nylon ends. Lower mouldings are bonded in with polyurethane adhesive sealant. Upper mouldings are riveted or screwed in. The upper **daggerboard** moulding shows the type of boat.

Lower mouldings are sealed, however over time there may be some water ingress. If this occurs foils should be inverted to allow water removal through the drain holes in the top of the moulding.

Foils contain closed cell foam to ensure buoyancy and limit potential water ingress.

Maintenance

- Foils should be rinsed with fresh water after use.
- Anodising will prevent surface corrosion, however if surface damage does occur the aluminium should be polished with wax polish e.g. car polish.
- Nylon mouldings are maintenance free but can be replaced if damaged.
- If you run aground hard with the **daggerboard** down, you should check that the hull has not been punctured at the front or the trailing edge of the **daggerboard** case. Special 'shock absorbing' pads have been fitted at these points to reduce the risk of damage, and these can be replaced if damaged.

If you are going to trail your boat frequently, you may wish to invest in some RS Racing padded rudder bags. These will protect your RS Feva from any damage caused by the foils.

RS *Feva* 5.2 Spar Care

The **mast** and **boom** are aluminium. Wash with fresh water as often as possible, both inside and out. Check all of the riveted fittings on a regular basis for any signs of corrosion or wear.

RS *Feva* 5.3 Sail Care

The **mainsail** and **Jib** should be rolled and stored dry, out of direct sunlight. When using a new sail for the first time, try to avoid extreme conditions as high loads on new sailcloth can diminish the racing life of the sail.

If your sail is stained in any way, try to remove it using a light detergent and warm water. DO NOT attempt to launder the sail yourself.

A sail can be temporarily repaired using a self-adhesive cloth tape, such as Dacron or Mylar. The sail should be returned to a sail maker for a professional repair. Check for wear and tear, especially around the batten pockets, on a regular basis.

RS
Feva **5.5 Fixtures and Fittings**

All of the fixtures and fittings have been designed for a specific purpose in the boat. These items may break when placed under any unnecessary load, or when used for a different function to their intended purpose. To ensure optimum performance, wash the fixtures and fittings with fresh water regularly, checking shackles, bolts, etc. for tightness.

1. This warranty is given in addition to all rights given by statute or otherwise.
2. RS Sailing warrants all boats and component parts manufactured by it to be free from defects in materials and workmanship under normal use and circumstances, and the exercise of prudent seamanship, for a period of twelve (12) months from the date of commissioning by the original owner. The owner must exercise routine maintenance and care.
3. This warranty does not apply to defects in surface coatings caused by weathering or normal use and wear.
4. This warranty does not apply if the boat has been altered, modified, or repaired without prior written approval of RS Sailing. Any changes to the hull structure, deck structure, rig or foils without the written approval of RS Sailing will void this warranty.
5. Warranty claims for materials or equipment not manufactured by RS Sailing can be made directly to the relevant manufacturer. RS Sailing warrants that these parts were installed correctly and according to the instructions provided by the manufacturer.
6. Warranty claims shall be made to RS Sailing as soon as practicable and, in any event, within 28 days upon discovery of a defect. No repairs under warranty are to be undertaken without written approval of RS Sailing.
7. Upon approval of a warranty claim, RS Sailing may, at its expense, repair or replace the component. In all cases, the replacement will be equal in value to the original component.
8. Due to the continuing evolution of the marine market, RS Sailing reserves the right to change the design, material, or construction of its products without incurring any obligation to incorporate such changes in products already built or in use.

Knot #1



Knot #2



Knot #3



Knot #4



Knot #5

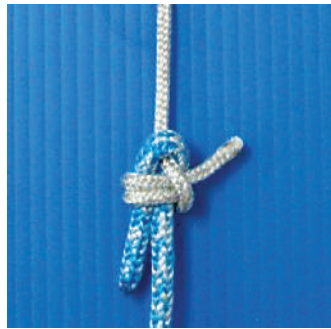

Knot #6



Knot #1 - Knot on knot

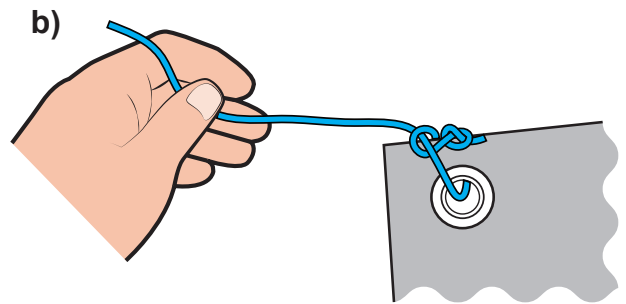
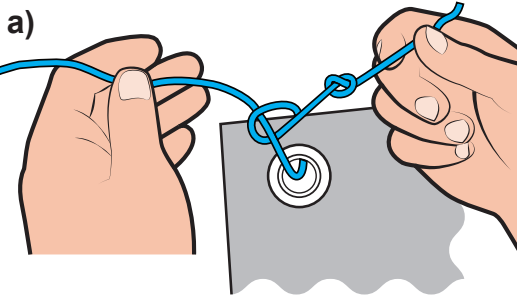

Knot #2 - Bowline

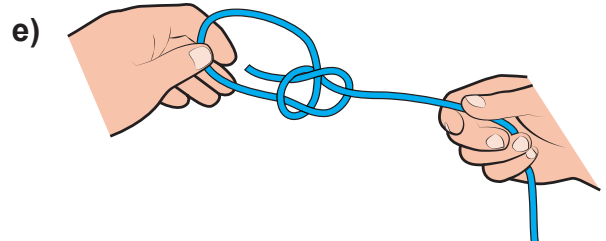
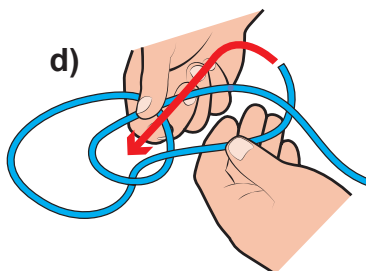
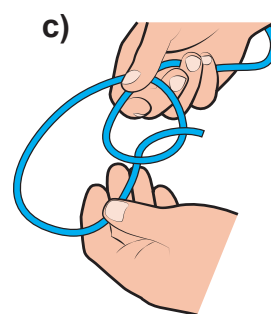
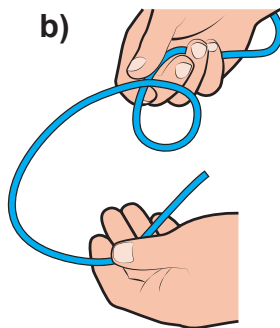
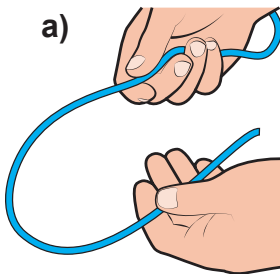

Knot #3 - Figure of eight

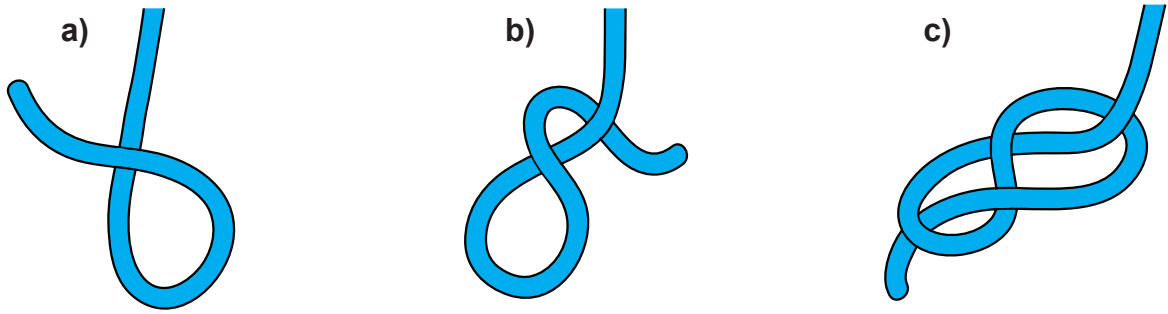

Knot #4 - Overhand knot

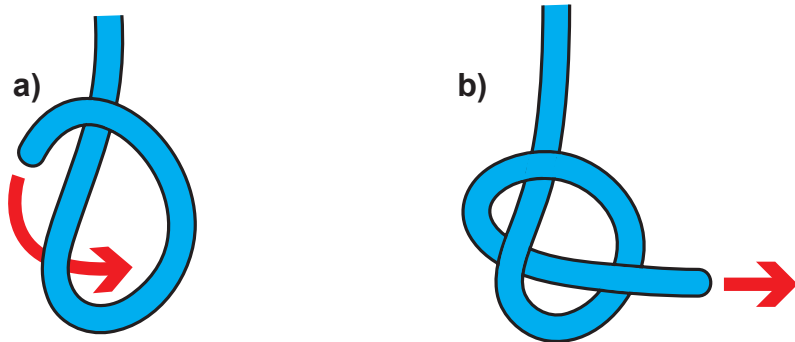

Knot #5 - Double sheet bend

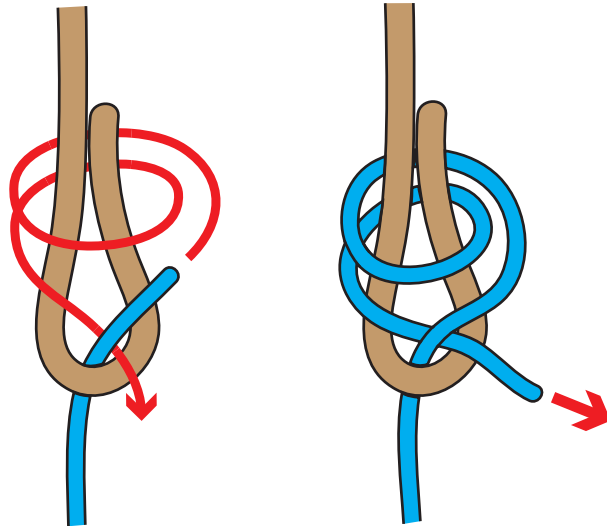

Knot #6 - Cow hitch

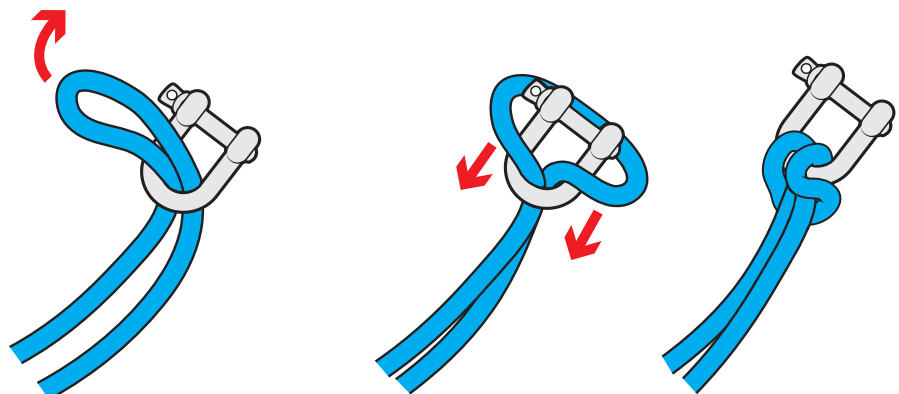

A

Aft	At the back
Anchor Line	Rope that attaches the anchor to the boat
Astern	Behind the boat
Asymmetric	Gennaker flown from a retractable pole at the bow

B

Back	To 'back the sail'; allowing the wind to fill the back of the sail
Bailer	A bucket or other container used for bailing water
Batten	A thin strip of wood/plastic inserted in the sail to keep it flat
Batten Key	A key used to adjust the batten
Batten Pocket	A pocket on the sail that holds the batten
Beam	Width of the boat at the widest point of the side of the boat. The phrase 'wind on the beam' means that the wind is coming from the side.
Bear away	To turn downwind
Beat	To sail a zig-zag course to make progress upwind
Beaufort Scale	A measure of wind strength, from Force 1 to Force 12
Bilge Rail	The moulded line that marks the transition from the side to the bottom of the hull
Block	A pulley used for sail control lines
Boom	The spar at the bottom edge of sail
Boom Pad	The pad that fits onto the boom
Bow	The front of the boat
Bow Lifting Handle	The handle at the front of the boat, used for lifting
Bowline	A useful and reliable knot, with a loop in it
Bow Snubber	The part of the trolley that the bow rests on
Builder's Plate	Plate that contains build information
Bung	A stopper for the drain hole

Buoy	Floating object attached to the bottom of sea – used variously for navigation, mooring, and to mark out a race course
Buoyancy Aid	Helps you to stay afloat if you fall in the water
Buoyancy Compartment	Water-tight compartment in the hull that maintains buoyancy
Burgee	Small flag at the top of the mast to show wind direction

C

Capsize	To overturn
Capsize Recovery	To right, or recover, the boat after a capsize
Catamaran	A boat with two hulls
Centreboard	The foil that sits below the hull to counteract the sideways push of the wind, and to create forward motion
Centreboard Case	The casing in the hull in which the centreboard sits
Centreline	An imaginary line that runs through the centre of the hull, from the bow to the stern
Chart datum	Depths shown on a chart, at the lowest possible tide
Cleat	A device to grip ropes and hold them in place – some grip automatically, while others need the rope tying around them
Clew	Lower corner of the sail, closest to the stern
Close hauled	Sailing as close to the wind as you can; point of sailing to sail upwind
Cockpit	The open area in the boat providing space for the helm and the crew
Collision Regulations	The 'rules of the road' to avoid collisions
Compass Rose	The compass shown on a chart to aid navigation
Crew	Helps the helmsman to sail the boat, and usually handles the jib sheets
Cutter	A boat with two headsails or jibs

D

Dacron	A brand of polyester sailcloth that is wrinkle-resistant and strong
Deck	A floor-like surface occupying part of the hull
Deck Moulding	A moulded deck
Downhaul	Applies downwards tension to a sail
Downwind	To sail in the direction that the wind is blowing
Drain Hole	A hole in the hull from which trapped water can be drained

Draught The depth of the vessel below the surface

E

Ease To 'ease sheets' means to let the sail out gently

F

Fairlead A pulley block used to guide a rope to avoid chafing

Foils The daggerboard and the rudder

Foot The bottom edge of a sail

Fore Towards the front of the boat

Forestay The wire line that runs from the front of the mast to the bow of the hull, holding the mast in position

Furl To gather a sail into a compact roll and bind it against the mast or forestay

G

Gennaker A large sail that is hoisted when sailing downwind

Gennaker Chute Webbing pocket in which the gennaker is stowed when not hoisted

Gennaker Pole The sprit that protrudes from the front of the hull, to which the tack of the gennaker is attached

Gnav Bar Bar that sits between the mast and the boom, performing the same function as a kicking strap

Gnav Control Line Line that applies and releases tension to the gnav

Gooseneck The 'jaws' of the boom that clip onto the mast

Gunwhale The top edge of the hull, that you sit on when leaning out to balance the boat

Gybe To change tack by turning the stern of the boat through the wind.

H

Halyard The rope used to hoist sails

Halyard Bag Bag attached to the hull, in which the halyards can be stowed

Head The top corner of a sail

'Head to Wind'	To point the bow in the direction that the wind is blowing from, causing the sails to flap
'Heave to'	To stop the boat by easing the main sheet and backing the jib
Heel	A boat 'heels' when it leans over due to the sideways force of the wind
Helm/Helmsman	The person who steers the boat, or another name for the tiller
Hoist Block	Block behind which the gennaker halyard is pulled when hoisting the gennaker
Hull	The hollow, lower-most part of the boat, floating partially submerged and supporting the rest of the boat

I

'Into the Wind'	To point the bow in the direction that the wind is blowing from, causing the sails to flap
Inversion	A capsizing where the boat turns upside down, or 'turtles'

J

Jammer	Another word for a cleat
Jib	The small sail in front of the mast
Jib Sheet	The rope used to control the jib

K

Kicking strap	The rope system that is attached to the base of the mast and the boom, helping to hold the boom down
Knot	A measurement of speed, based on one minute of latitude

L

Launching	To leave the slipway
-----------	----------------------

Latitude	Imaginary lines running parallel round the globe from east to west. They help you measure position and distance on a chart.
Leech	The back edge of the sail
Leeward	The part of the boat furthest away from the direction in which the wind is blowing
Leeway	The amount of sideways drift caused by the wind
Leverage	The result of using crew weight as a 'lever' to counteract heel caused by the wind
Lie to	A way of stopping the boat temporarily by easing sheets on a close reach
Lifejacket	Unlike a buoyancy aid, a lifejacket will keep a person fully afloat with their head clear of the water
Longitude	Imaginary lines running round the globe from north to south, like segments of an orange. Used with lines of latitude to measure position and distance
Lower Furling Unit	The fitting at the bottom of the forestay that enables the jib to be furled
Luff	The front edge of the sail

M

Mainsail	The largest sail on a boat
Mainsail Clew Slug	The fitting that sits in the track on the boom, to which the clew of the mainsail is attached
Mainsheet	The rope used to control the mainsail
Mainsheet Bridle	The rope runs across the transom of the boat, to which the mainsheet is attached
Mainsheet Centre Block	The main block, usually fixed to the cockpit floor, through which the mainsheet passes
Man Overboard Recovery	The act of recovering a 'man overboard' from the water
Mast	The spar that the sails are hoisted up
Mast Foot	The bottom of the mast
Mast Gate	Fitting which closes across the front of the mast at deck level, holding the mast in place

Mast Lower Section	The bottom section of a two-piece mast
Mast Step	The fitting on the deck that the mast fits into
Mast Top Section	The top section of a two-piece mast
Meteorology	The study of weather forecasting
Moor	To tie the boat to a fixed object
Mylar	A brand of strong, thin, polyester film used to make racing sails

N

National Sailing Federation	Body that governs sailing in a nation. In the UK, this is the Royal Yachting Association
Navigation	To find a way from one point to the other
Neap Tide	Tides with the smallest tidal change

O

'Off the Wind'	To sail in the direction that the wind is blowing
Outboard Bracket Kit	Bracket which enables an outboard engine to be attached to the transom
Outboard Engin	Small portable engine that attaches to the transom
Outhaul	The control line that applies tension to the foot of the sail, by pulling the sail along the boom
Outhaul Hook	The fitting on the boom that hooks the eye at the back of the sail, and to which the outhaul is attached

P

Painter	The rope at the bow used to tie the boat to a fixed object
Pontoon	A floating jetty to moor your boat to
Port	The left-hand side of the boat, when facing forwards

R

RS Dealer	A third-party who sells the RS range
Reach	Sailing with the wind on the side of the boat

Reef	To make the sails smaller in strong winds
Retaining Pin	On a trolley, to hold the launching trolley to the road base
Road Base	A trolley that you place your boat and launching trolley upon to trail behind a vehicle
Rowlocks	U shaped fittings that fix onto the gunwale and holds your oars in position while rowing
Rowlock Holes	The holes in the gunwhale into which the rowlocks fit
Rudder	The foil that, when attached to the stern, controls the direction of the boat
Rudder Blade	The large, rigid, thin part of the rudder
Rudder Downhaul	The control line that enables you to pull the rudder into place
Rudder Pintle	The fitting on the transom onto which the rudder stock fits
Rudder Stock	The top part of the rudder, usually including the tiller, into which the rudder blade fits, and which then attaches to the rudder pintle
Run	To 'run with the wind', or to sail in the direction that the wind is blowing

S

Safety-Boat Cover	Support boats, usually RIBs, in case of emergency
Sail	An area of material attached to the boat that uses the wind to create forward motion
Sailmaker	A manufacturer of sails
Sail Number	The unique number allocated to a boat, displayed on the sail when racing
Sail Pressure	A sail has 'pressure' when it is working with the wind to create motion
Sailing Regatta	An event that usually comprises of a number of sailing races
Shackle	A metal fitting for attaching ropes to blocks, etc.
Shackle Key	Small key used to undo tight shackles
Sheet	A rope that controls a sail
Shroud	The wires that are attached to the mast and the hull, holding the mast up
Side Safety Line	The line that runs along the side of the hull
Single Handed	To sail a boat alone
Single-Line Reefing System	An efficient method of reefing with one line

Slider	Sliding fitting on the boom to which the gnav bar is attached
Soundings	The numbers on a chart showing depth
Spars	The poles, usually carbon or aluminium, to which the sail is attached
Spreaders	Metal fittings attached to the mast which hold the shrouds out
Spring Tide	The tides with the biggest range and strongest currents
Starboard.	The right-hand side of the boat, when facing forwards
Stern	The back of the boat
Stern Lifting Handles	The handles at the stern, used for lifting the boat
Stopper Knot	A form of knot used to prevent a rope from sliding through a fitting, such as a pulley or a cleat

T

Tack	a) To change direction by turning the bow of the boat through the wind b) The bottom front corner of a sail
Tack Bar	The bar at the bow of the hull, to which the tack of the jib is attached
Tack Line	The rope that emerges from the front of the gennaker pole, to which the tack of the gennaker is attached
Tender	A small vessel, usually used to transport crew to a larger vessel
Tidal height	The depth of water above chart datum
Tidal range	The difference between the depth of water at low and high tide
Tidal stream	The direction in which the tide is flowing
Tiller	The stick attached to the rudder, used to steer the boat
Tiller Extension	A pole attached to the tiller to extend its reach, usually used when hiking
Toe Straps	The straps to tuck your feet under when you lean out to balance the boat.
Top Furling Unit	Fitting at the top of the forestay which enables the jib to be furled
Towing Line	A rope attached to the boat, used to connect to a towing vessel
Transit	An imaginary line between two fixed objects, used to ensure that you are staying on course
Transom	The vertical surface at the back of the boat
Trim	Keeping the boat level fore and aft
Trimaran	A boat with three hulls
Trolley	A wheeled structure, used to move the boat around on land
Trolley Supports	The part of the trolley in direct contact with the hull

U

'Under Weigh' A term derived from the act of 'weighing' anchor, meaning to be in motion

Upwind To sail against the direction in which the wind is blowing

W

Wetsuit Neoprene sailing suit designed to keep you warm when wet

Windward The part of the boat closest to the direction in which the wind is blowing