

RS neo

Rigging Manual V4



PLEASE FOLLOW RIGGING MANUAL IN THE CORRECT ORDER



RS neo

Contents

1. Introduction	1
2. Technical data	2
3. Commissioning	3 - 24
3.1 - Preparation	4
3.2 - Unpacking	4
3.3a - Customer pack contents	4-5
3.3b - Rope pack contents	5
3.4a - Adding the centre toestraps	6-7
3.4b - Adding the side toestraps	8
3.4c - Adding the cockpit bung	8
3.5 - Adding the mainsheet bridle	9
3.6 - Rigging the mast	10 - 12
3.7 - Rigging the boom	12 - 18
3.7a - Rigging the outhaul.....	18-19
3.8 - Mainsail	20 - 22
3.9 - Daggerboard	23
3.10 - Rudder	24
4. Completion	25 - 26
5. Sailing Hints	27 - 29
5.1 - Introduction	28
5.2 - Launching	28
5.3 - Leaving the beach	28
5.4 - Sailing close hauled and tacking	29
5.5 - Sailing downwind and gybing	29
5.6 - Top cover	29
6. Maintenance	30 - 33
6.1 - Boat care	31
6.2 - Foil care	32
6.3 - Spar care	32
6.4 - Sail care	32
6.5 - Fixtures and fittings	33
7. Warranty	34
8. Knots	35 - 36
9. Glossary	37-45

1. Introduction

Congratulations on the purchase of your new RS Neo and thank you for choosing an RS product. We are confident that you will have many hours of great sailing and racing in this truly excellent design.

The RS Neo is an exciting boat to sail and offers fantastic performance. This manual has been compiled to help you to gain the maximum enjoyment from your RS Neo, in a safe manner. It contains details of the craft, the equipment supplied or fitted, its systems, and information on its safe operation and maintenance. Please read this manual carefully and be sure that you understand its contents before using your RS Neo.

This manual will not instruct you in boating safety or seamanship. If this is your first boat, or if you are changing to a type of craft that you are not familiar with, for your own safety and comfort, please ensure that you have adequate experience before assuming command of the craft. If you are unsure, RS, your RS dealer, or your national sailing federation – for example, the Royal Yachting Association – will be able to advise you of a local sailing school, or a competent instructor.

RS Sailing highly recommends using RS supplied equipment for usage and storing of your craft. Deviation from using RS supplied equipment, such as sails and storage solutions, will require consultation with RS Sailing. Failure to do so may affect Warranty claims and Goodwill outcomes.

Please keep this manual in a secure place and hand it over to the new owner if you sell the boat.

For further information, spares, and accessories, please contact:

RS Sailing
Premier Way
Abbey Park
Romsey
Hants SO51 9DQ
Tel.: +44(0)1794 526760
Fax: +44(0)1794 278418
E-mail: www.info@rssailing.com

For details on your local RS dealer, please visit www.rssailing.com

2. ^{RS}neo Technical Data

Length Overall (LOA)	3.53 m
Beam	1.42 m
Hull Weight	60 kg
Mainsail	6.0 m ²

***RS* neo**

3. Commissioning



PLEASE FOLLOW RIGGING MANUAL IN THE CORRECT ORDER



***RS* neo**

RS neo 3.1 - Preparation

Your RS Neo comes complete with all the components necessary to take the boat sailing.







DO NOT use a knife or other sharp object to cut through packaging containing parts – you may damage the contents!

Whilst your RS Neo has been carefully prepared, it is important that new owners should check that shackles and knots are tight. This is especially important when the boat is new, as travelling can loosen seemingly tight fittings and knots. It is also important to check such items prior to sailing regularly.

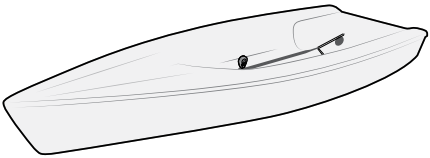
RS neo 3.2 - Unpacking











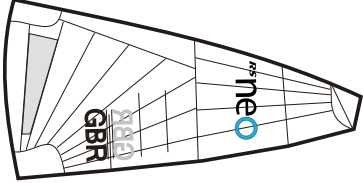

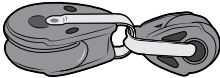

Having unpacked your RS Neo, you should check that you have all of the items listed before throwing away any of the packing, as there may be some small items still wrapped.

RS neo 3.3a - Customer pack contents



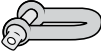











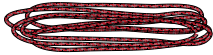

	Hull	1
	Lower mast	1
	Top mast	1
	Boom	1
	Rudder	1
	Tiller extension	1
	Dagger board	1

- Tools Required:**
- 4mm Allen key
 - #2 Pozidrive screwdriver
 - Pliers
 - Rope Cutter (or knife and flame)
 - Flat tip screwdriver

RS neo 3.3a - Customer pack contents

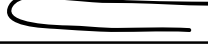
	Mainsail	1
	Battens	3
	Dagger board retainer hook	1
	Centre toestay	1
	Side toestay	2
	Mainsheet traveller block	1
	40mm single block	3
	30mm single block	1
	20mm single block	2
	20mm single block with becket	1
	20mm double block	1
	6mm bow shackle	1
	Rotating cleats	2
	Black bobble	3
	Orange bobble	1
	Cockpit bung	1

RS neo 3.3b - Rope pack contents

	Mainsheet	1
	Dagger board retainer	1
	Cockpit bung string	1
	Rear mainsheet bridle	1
	Centre to strap bungy	1
	Mainsheet block boom ties	2
	Downhaul control line	1
	Downhaul primary	1
	Outhaul	1
	Outhaul bungy	1
	Kicker control line	1
	Kicker primary	1
	Mast retainer bobble	1
	Mast retainer loop	1
	Main halyard tail	1
	Main halyard primary	1
	Clew stop	1

RS neo 3.4a - Adding the centre toestraps

a) Locate the centre to strap in the customer fittings pack.

To add the centre to strap you will need a 4mm Allen key.

Make sure you attach the to strap the right way round. The end with the webbing loop is the forward end and attaches to to strap fitting in the centre of the boat just aft of the mainsheet ratchet block. The end with the buckle is the aft end.

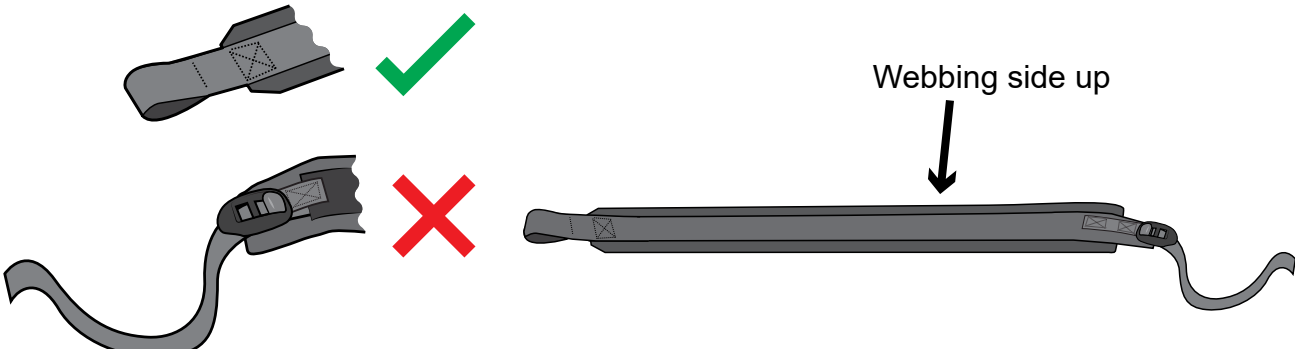

RS neo 3.4a - Adding the centre toestraps

b)

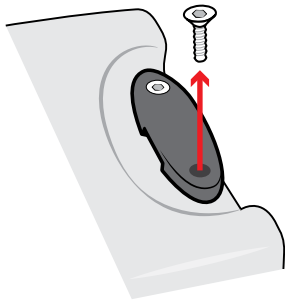

Remove **ONE** of the screws from the toetraps retainer.

c)

Rotate the toetraps retainer outwards to allow you to slide the webbing loop on the toetraps over it.

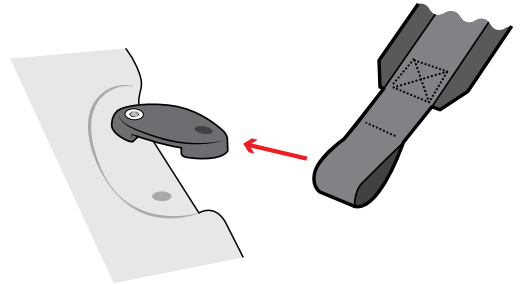

d)

Rotate the toetraps retainer back into position and replace the screw.

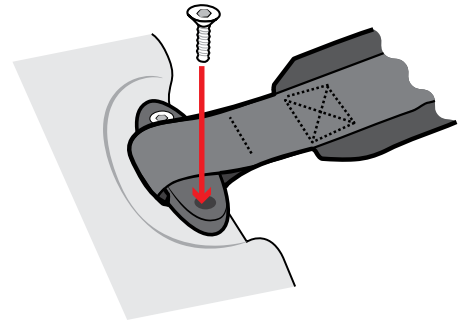
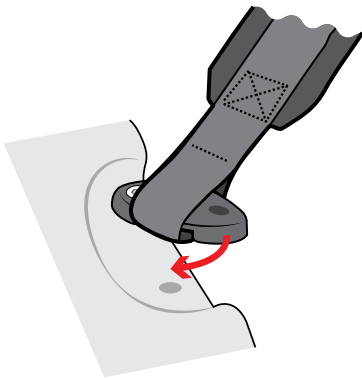

e)

You can now attach the aft toetraps end to the toetraps retainer using the buckle.

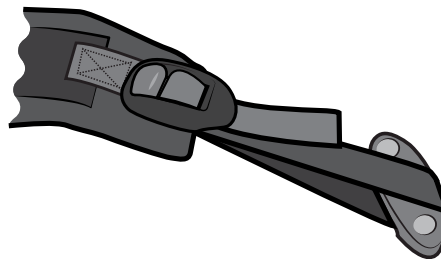
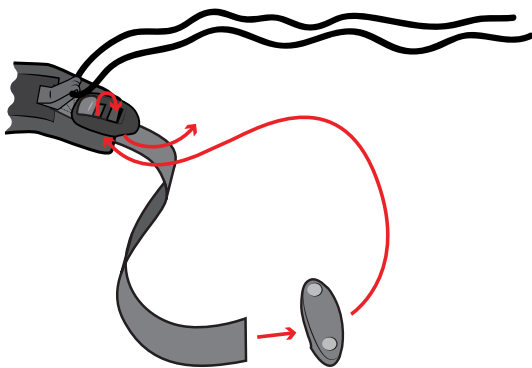

f)

Add the rear toetraps elastic.

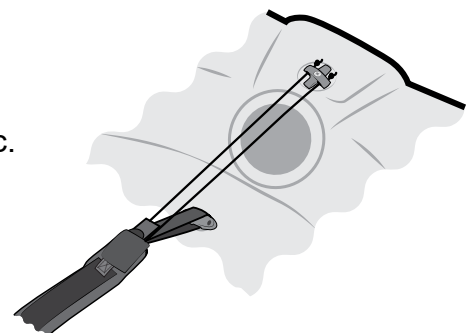
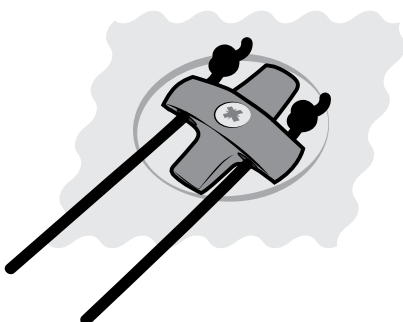

RS neo 3.4b - Adding the side toestraps

Locate the side toestraps in the customer fittings pack.



To add the side toestraps you will need a 4mm Allen key.

The side toestraps have a loop at each end. These loops attach to the fittings on the side tanks in the same way as the front end of the centre toestrap.

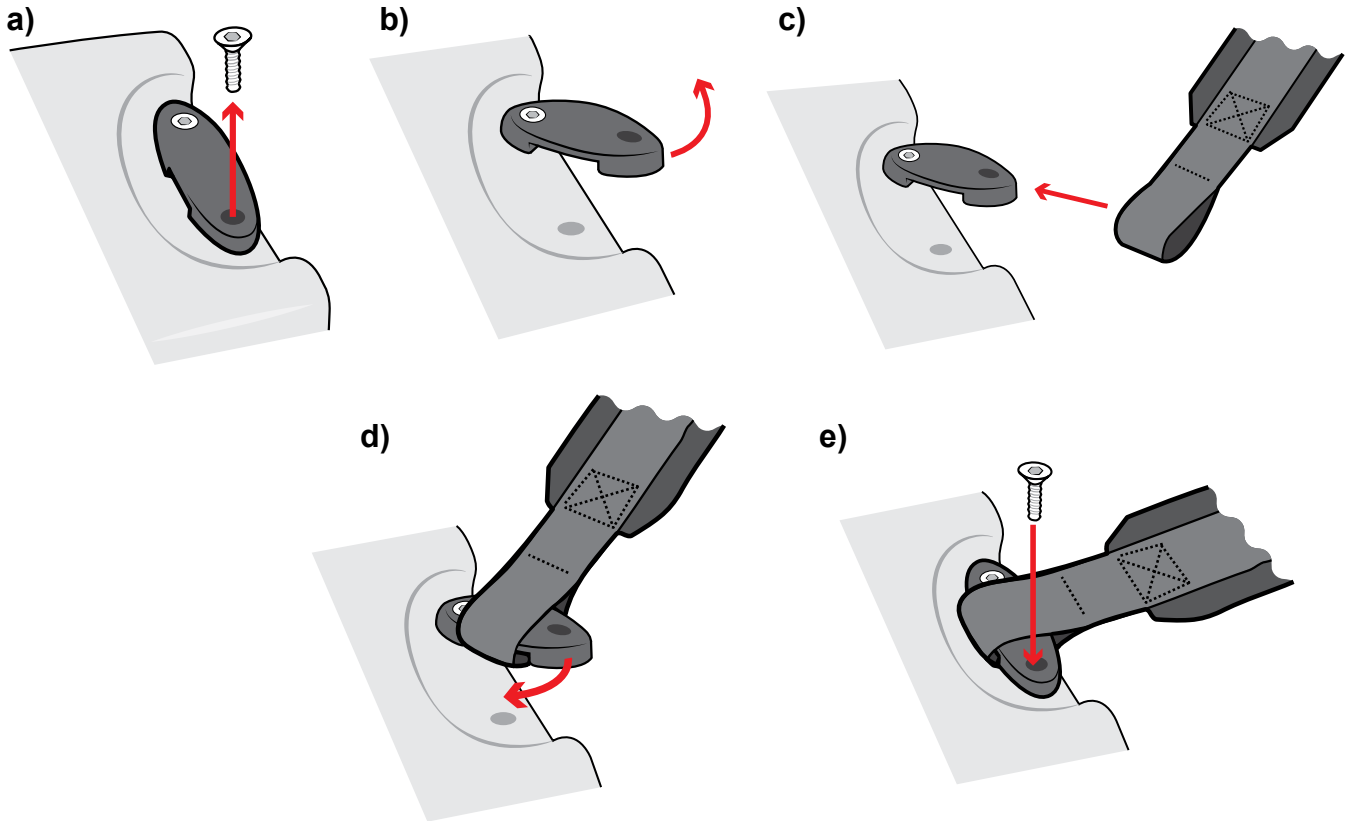
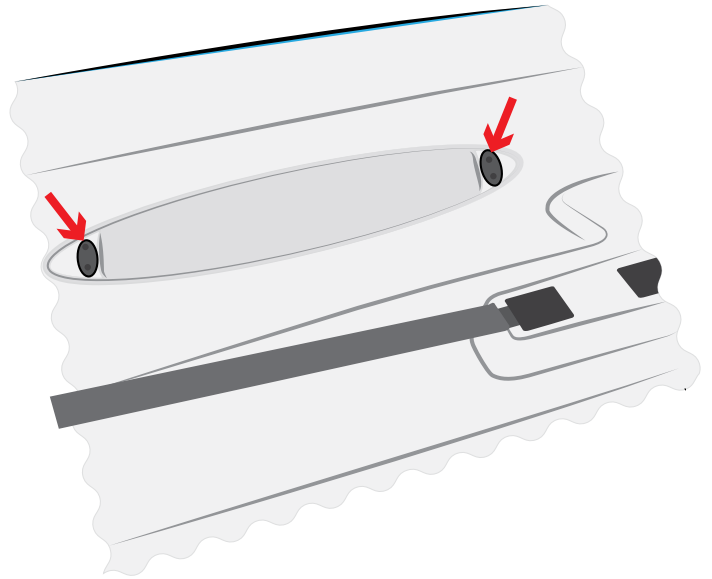

RS neo 3.4c - Adding the cockpit bung

Locate the bung and bung tie in the pack.

Thread the tie into the bung and then tie it to the webbing strap at the aft end of the centre toestrap with **knot #2**.

Push the bung into the hole in the cockpit floor.

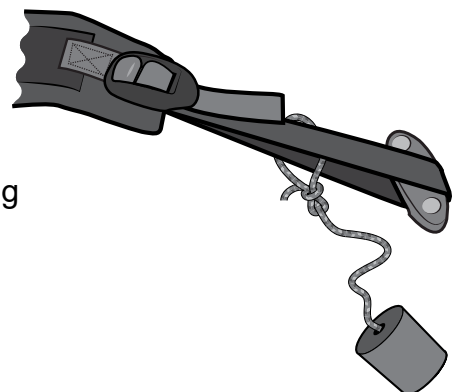

- a) Locate the mainsheet traveller block and rear mainsheet bridle from the packs.



- b) Tie a **#3 knot** (See section 8) in one end of the rear mainsheet bridle and pass it upwards through the hole in the gunwhale at the stern.

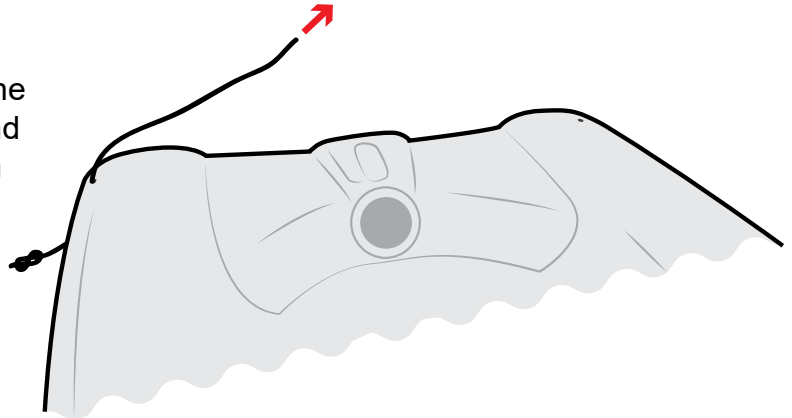

- c) Pass the mainsheet bridle through the smaller block.

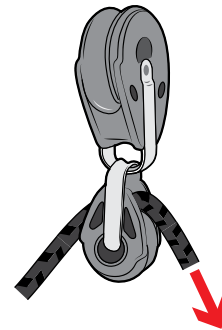

- d) Pass the mainsheet bridle down through the hole in the opposite gunwhale, adjust the bridle to the appropriate length, then tie a **#3 knot** in the tail.

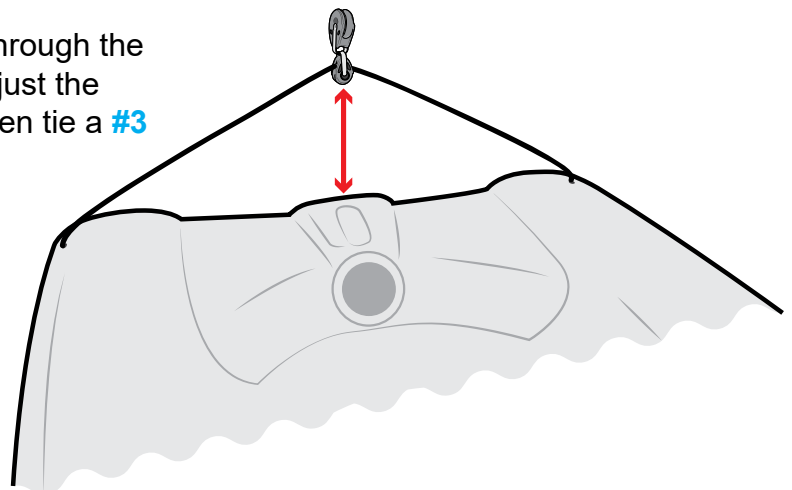

There are two different bridle lengths that we recommend.

For institutions who wish reduce the chance of tangling the mainsheet / traveller with the tiller / tiller extension, adjust the bridle so the block is 16cm above the deck.

For racers who want to allow the boom to come closer to the centre line and perform better upwind set the bridle so the block comes 60cm above the deck.

RS neo 3.6 - Rigging the mast

- a) Ensure that the sleeve and the inside of the tube are clean and free of debris. Neo rigs are designed with a tight engineering tolerance on the sleeve.



Ensure the tubes are aligned and push together. (The first part is often the hardest due to misalignment). If the tubes are hard to push together spray with maclube or a similar product.



- b) The thick section of the Main Halyard has two distinctive ends. One end has the core removed from the rope and is of reduced diameter. This is the end that attaches to the thin halyard tail. The thick end attaches to the plastic bobble.



Tie the thick and thin part of the main halyard together with **knot #5**.

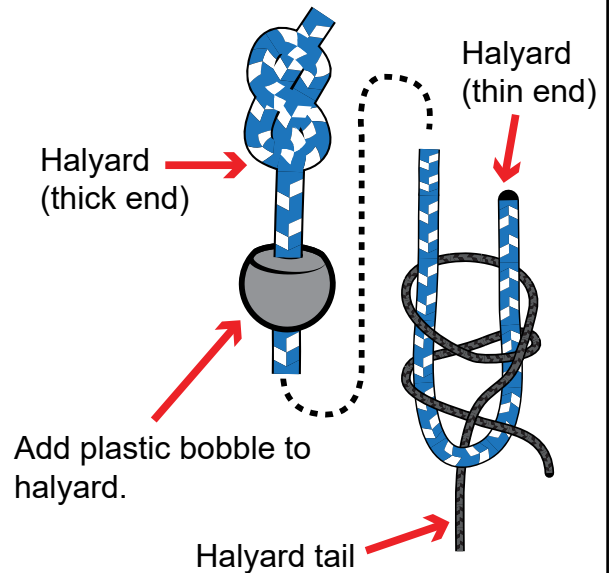

- c) Pass the halyard tail through the bullseye at the top of the mast.

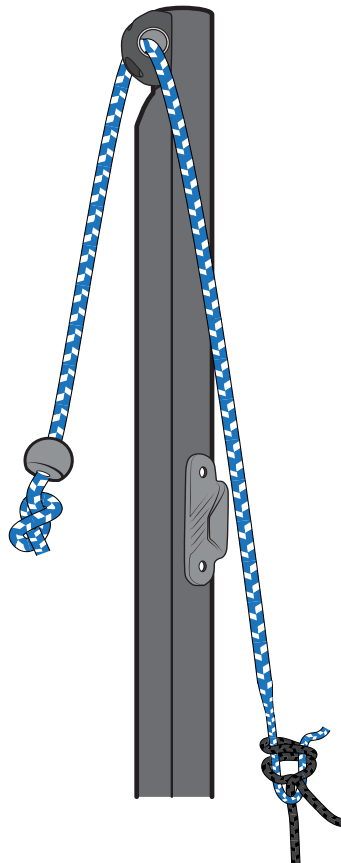

- d) To keep things neat while stepping the mast you can add the main halyard and tail to the lower cleat.

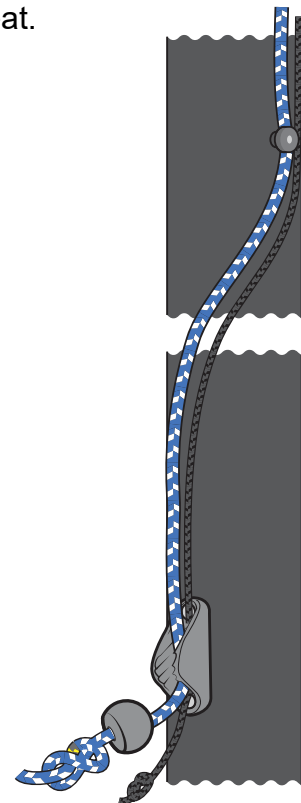

e)



MAKE SURE THERE ARE NO OVERHEAD POWER LINES

BE CAREFUL IN STRONG WINDS.

Then step the mast in the boat.

MAKE SURE THE MAST STEP IS FULLY LOCATED.

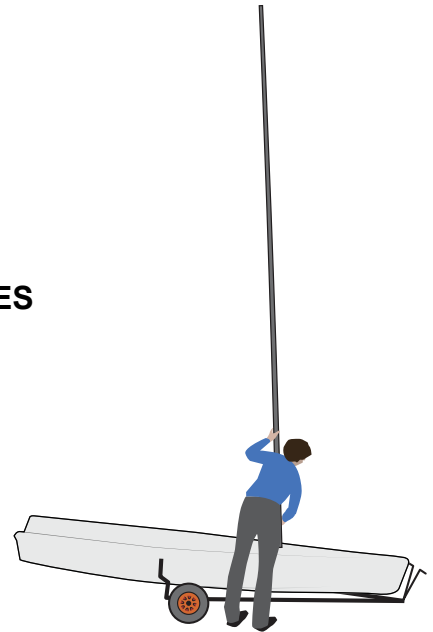

f) Locate the mast retainer, orange bobble and mast retainer loop in the rope pack.



g) Tie a **#4 knot** in one end of the mast retainer and pass it through the orange bobble.

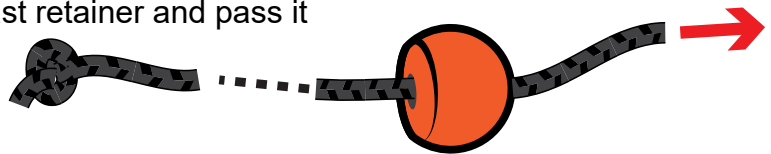

h) Pass the other end of the mast retainer underneath the port organiser next to the mast pot. Tie a **#3 knot** in the end to stop it pulling through.

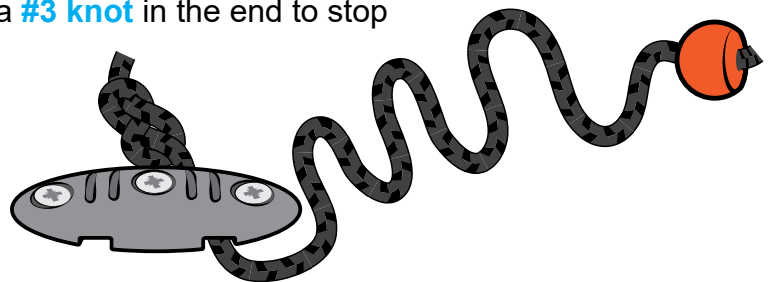

h)

Take the mast retainer loop and pass both ends down through the starboard organiser (next to the mast pot) and out from underneath. Tie 2 x #3 knots in the tails to stop them pulling back through.

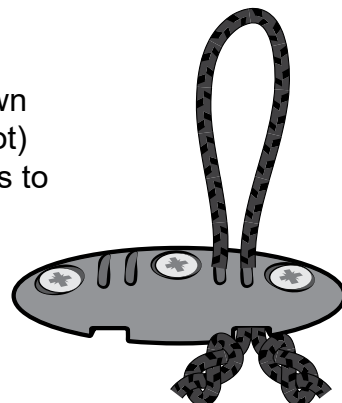

RS neo 3.6 - Rigging the mast

- i) Take the end of the mast restrainer and pass it clockwise the whole way around the mast, passing above the mushroom on the back of the mast.

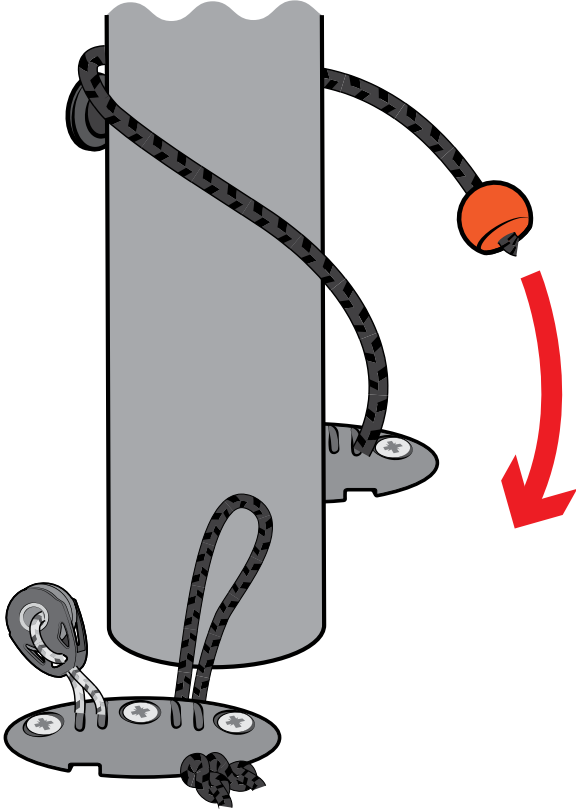

- j) Pass the bobble on through the rope hoop on the starboard organiser to hold it tight.

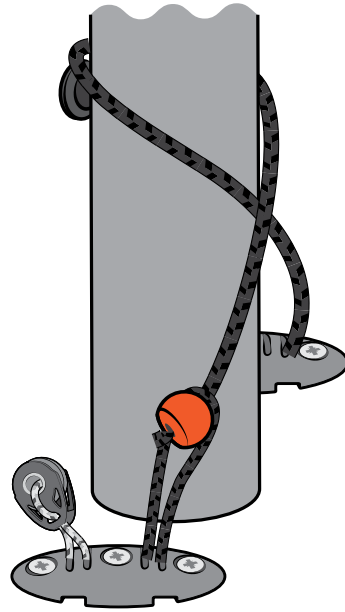

Adjust the length of the rope so it is just possible to pass the bobble through the loop. This will ensure the Mast restrainer functions as required. A loose Mast restrainer will allow the mast to become detached from the boat in the event of a capsize and risk damage to the boat and sailors

- k) Locate the 6mm shackle in the customer fittings pack.

Attach the shackle to the loop at the base of the mast with **knot #6**.

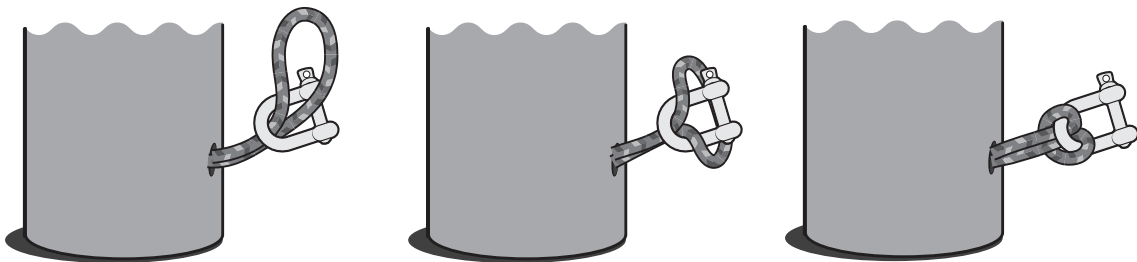

RS neo 3.7 - Rigging the boom

- a) **Outhaul system**

Locate the outhaul, outhaul elastic and black bobble in the rope pack.



- b) Tie **knot #4** in one end of the outhaul rope and add the bobble, then pass the tail through the bullseye at the end of the boom.

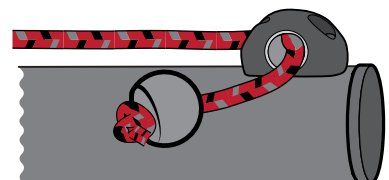

RS neo 3.7 - Rigging the boom

- c) Pass the end of the outhaul through the cleat on the boom.

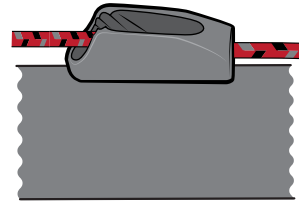

- d) Join the outhaul rope to the elastic with **knot #5**.



- e) Pass the elastic along the boom and through the eye at the forward end of the boom.

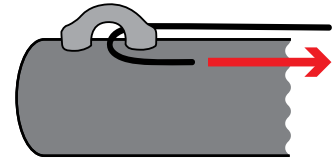

- f) Take the elastic back aft along the boom and tie it to the plastic fitting on top of the boom (which the mainsheet blocks are tied through) with **knot #2**.

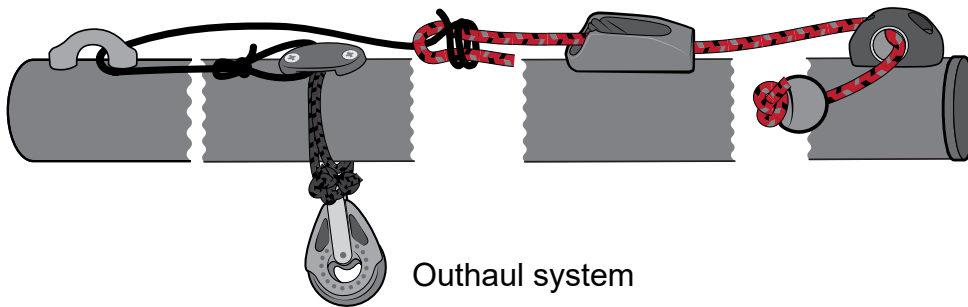

- g) Locate the two 40mm mainsheet blocks and rope ties from the packs. One block attaches to the midpoint of the boom, the other attaches through the eye at the end of the boom. The process of fitting them both is the same.

- h) Attach one end of the tie to the block with **knot #1**.

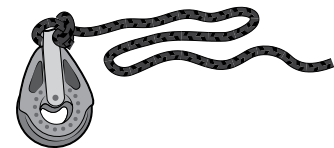

- i) Pass the rope through the eye, the whole way around the boom and through the eye again.

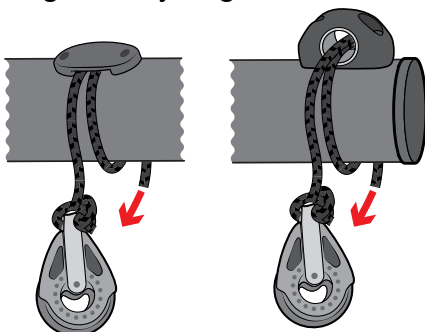

- j) Tie the other end of the rope to the block with **knot #1**. The block should be tight against the boom.

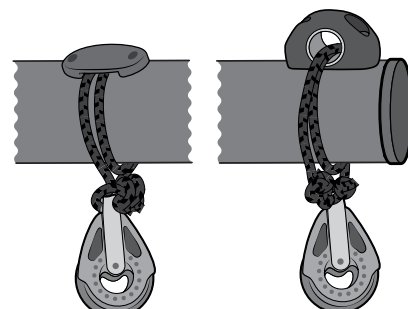

k) Vang system

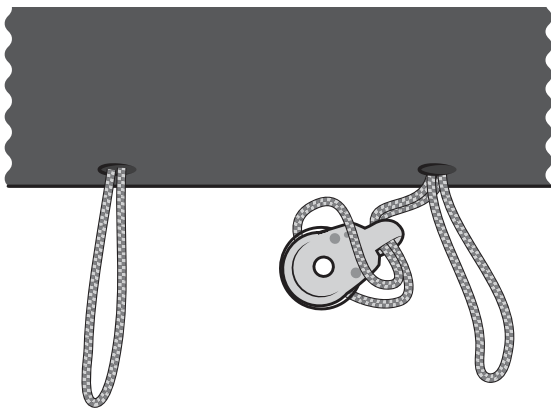

Cow hitch on the single block to the front rope hoop on the boom.

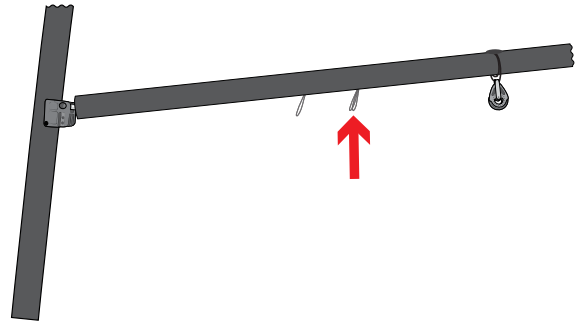

l)

Cow hitch the single block with becket onto the other rope loop which emerges from the same hole in the boom.

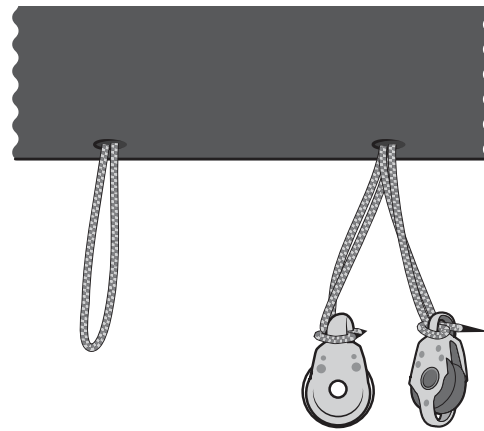
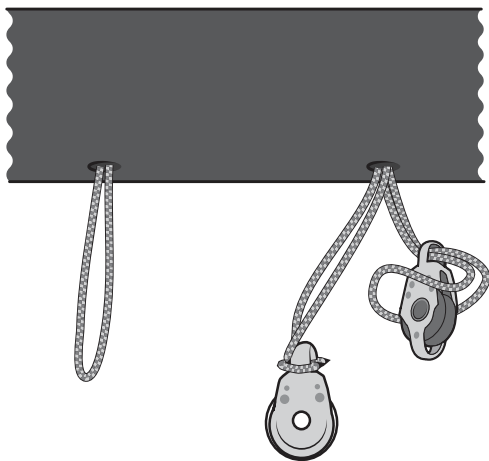

m)

Fold vang strop, leaving one half 100mm longer than the other.



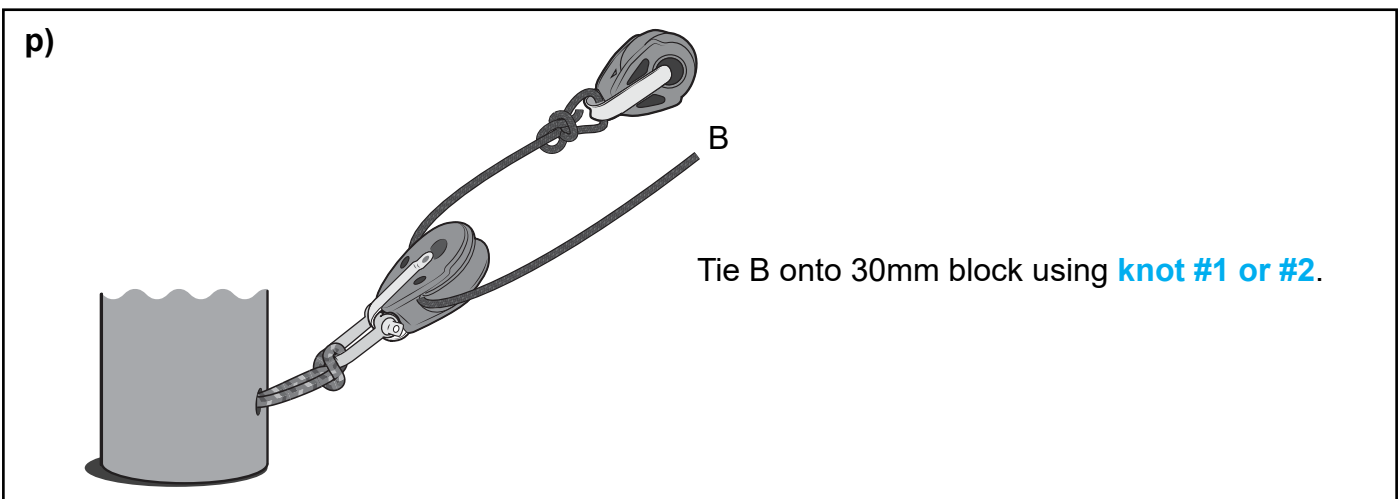
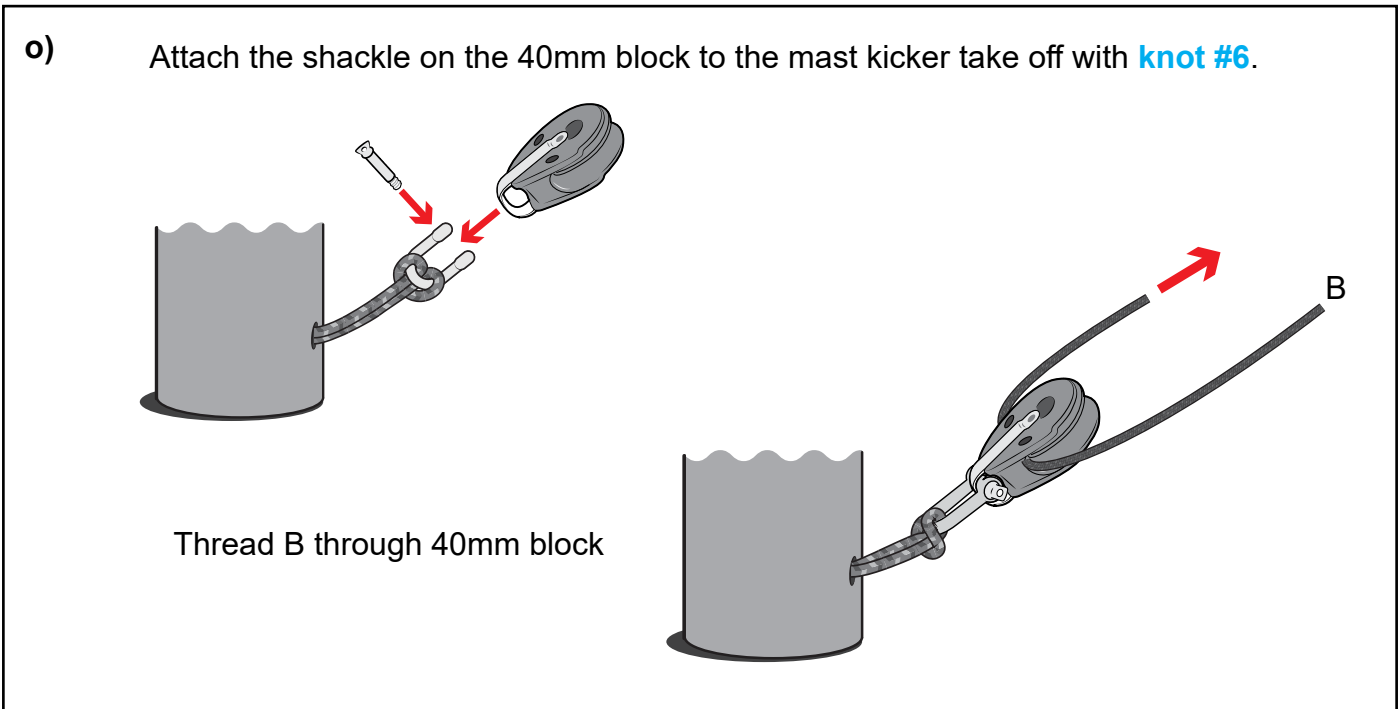
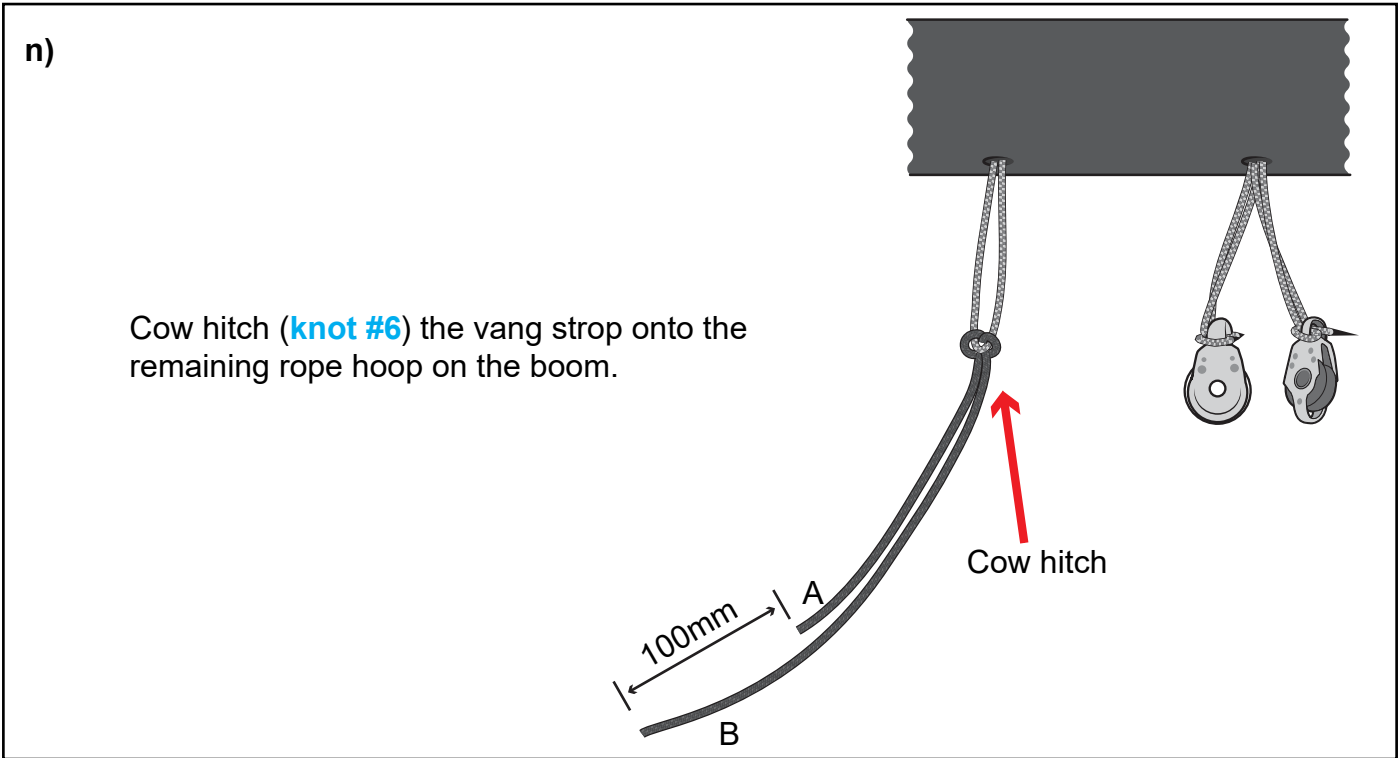

q)

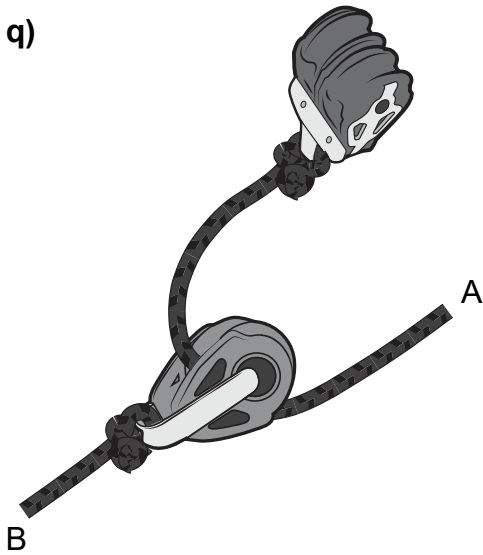

Feed the end of A through the 30mm block and tie the double block onto the end using **knot #1**.

r)

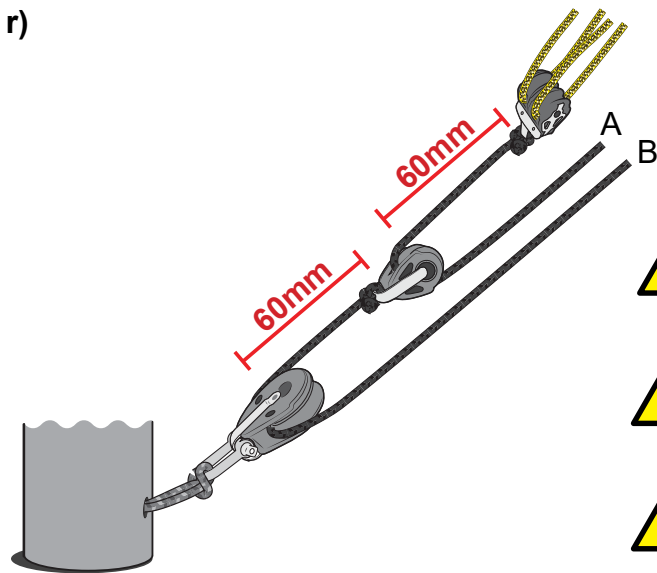

When pulled tight blocks should be 60mm apart.



Before sailing hoist the sail and make final adjustments.



You may need to adjust it again after the rope has stretched.

s)

VANG CONTROL LINE

Note: The control line is tapered at one end. This end will remain in the cockpit. Tie the non-tapered part to the becket on the boom block with **knot #2**. This now becomes Part **A** in the illustration.

Thread the vang control line through the blocks as shown.

E goes through the gooseneck in the next step.

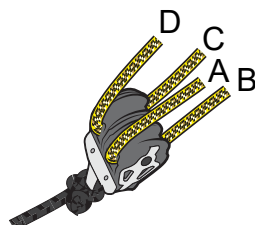
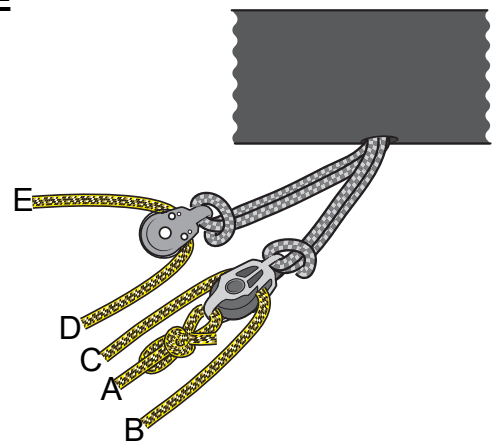

RS neo 3.7 - Rigging the boom

- t) Take the tail of the vang coming from the single block and feed it through the starboard slot on the gooseneck, around the turning block and down the mast.

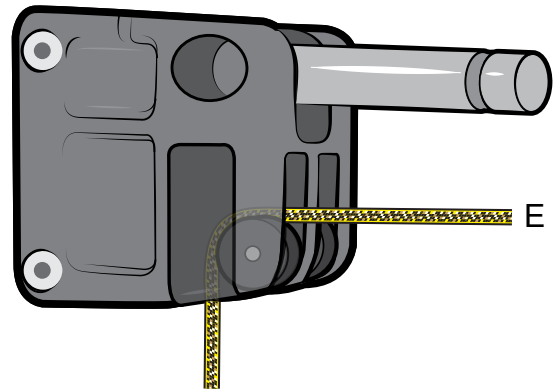

- u) Feed the tail of the vang around the rear block on the port organiser (A) and through the vang cleat (B).

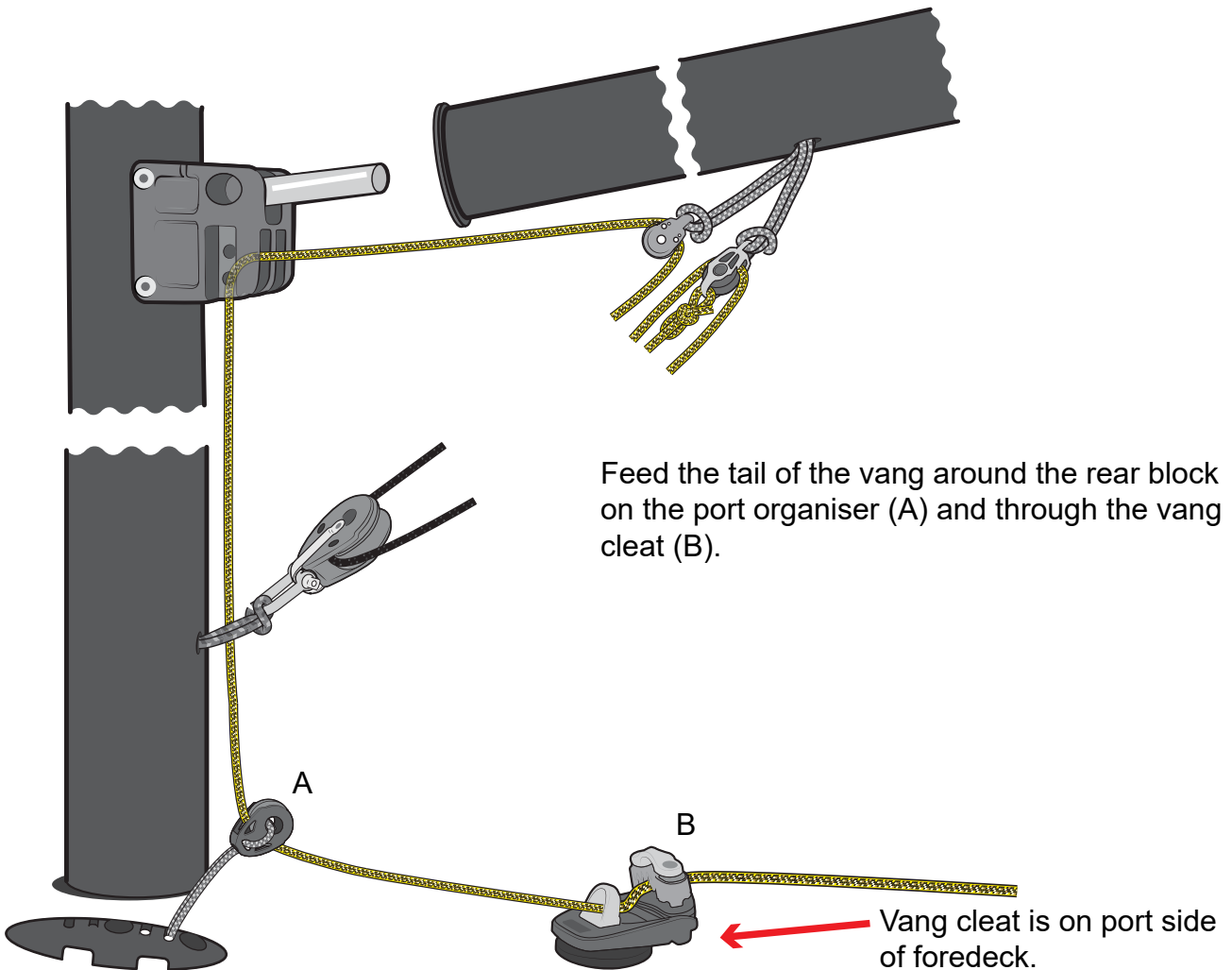

- v) Pass the tail aft and through the metal ring just behind the daggerboard case.
- This tail will tie to the tail of the downhaul control line in a later step.

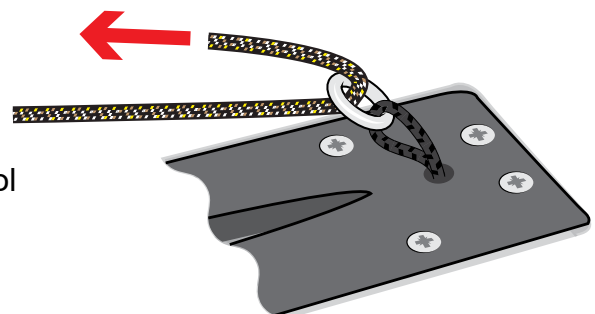

RS neo 3.7 - Rigging the boom

w)

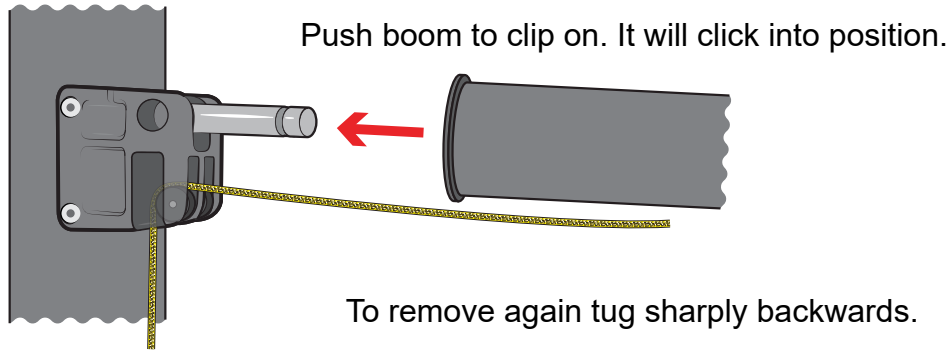

x)

MAINSHEET SYSTEM

Tie a figure of eight in one end of the mainsheet.

Feed the other end through the centre hole of the 40mm block on the end of the boom then thread through the blocks as shown.

Tie a figure of eight in the other end of the mainsheet with just enough slack that the boom can go to 90°.

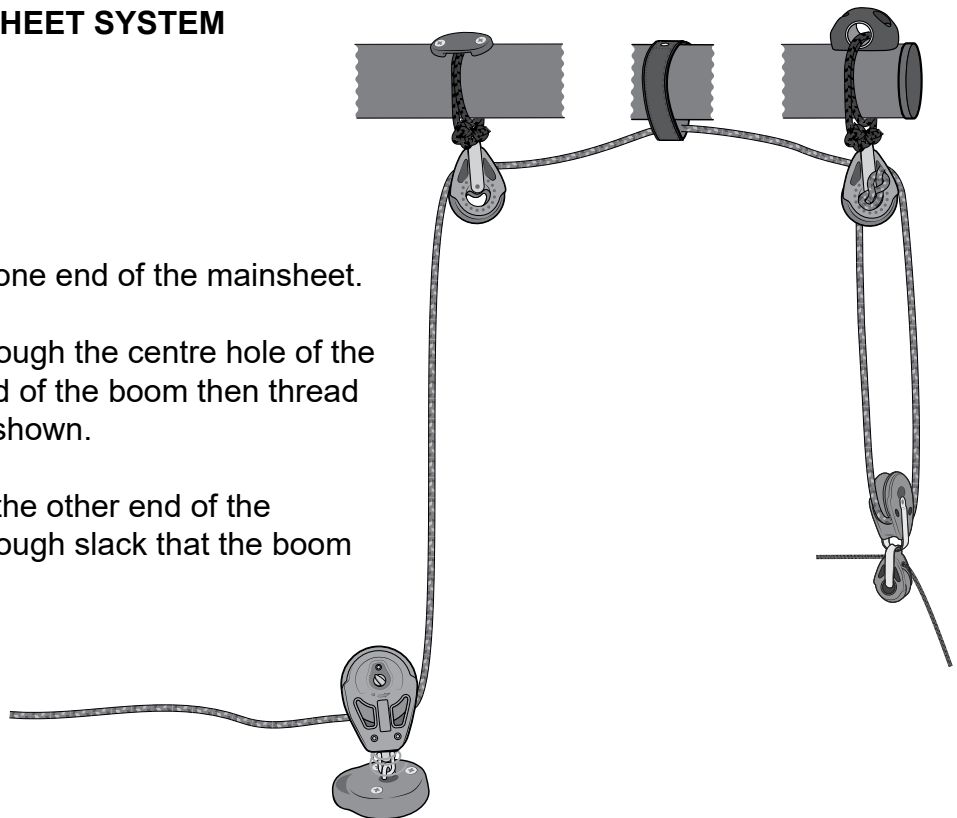

RS neo 3.7a - Rigging the downhaul

a)

Locate the downhaul primary, block and control line in the rope pack.



b)

Tie the downhaul primary onto the block with **knot #2**.



c)

The downhaul control line is tapered at one end. This end will remain in the cockpit.

Pass the non-tapered end under the starboard organiser and fasten with **knot #2**.

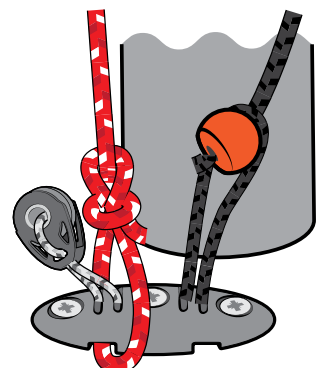

d)

Pass the other end of the downhaul control line through the block which you added to the downhaul primary in **step a**.



e)

Pass the end of the control through the block on the starboard organiser.

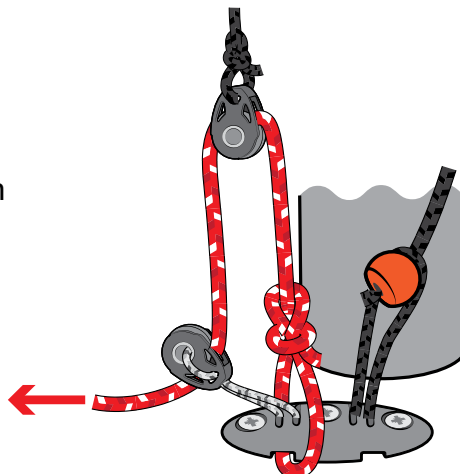

f)

Pass the end of the control line through the downhaul cleat (on the starboard side of the foredeck).

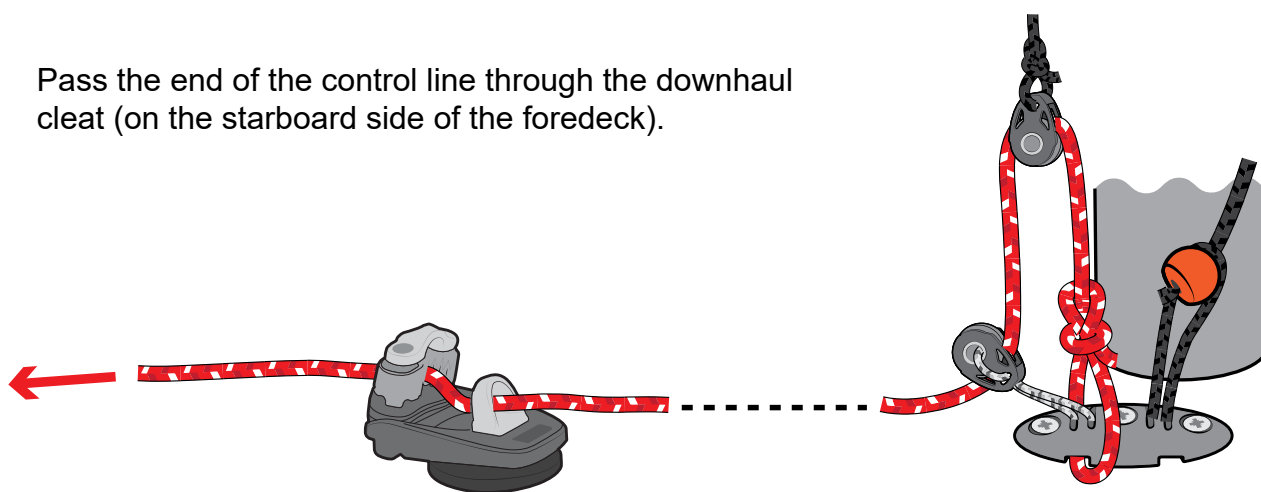

g)

Tie the tail of the downhaul to the tail of the kicker with a reef knot.

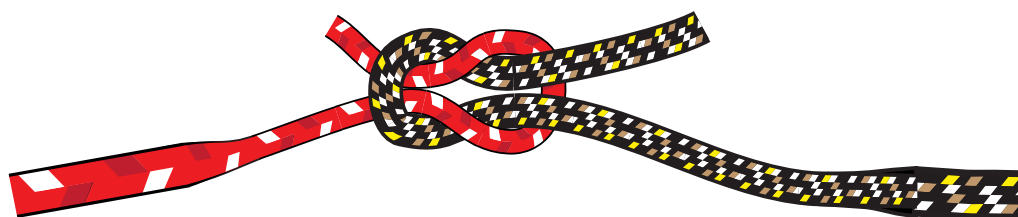

NOTE:

In order to keep the knot small the core has been removed from the end of both ropes.

a) Sail numbers are not a requirement but have been supplied if necessary.



Cut along dotted lines to form the correct sail numbers.

b)

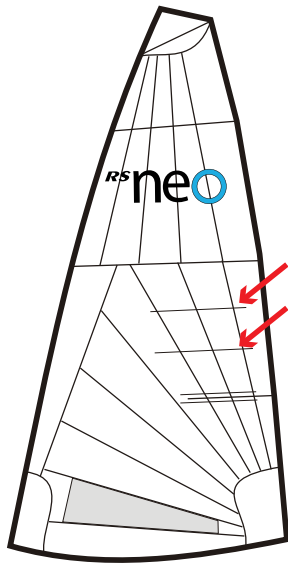

Unroll your new sail. Stick the sail numbers on sail, higher on the starboard side of the sail than the port, in the positions marked by the faint pencil lines.



NUMBERS MUST BE PLACED HIGHER ON THE STARBOARD SIDE.

c)

Leave a gap of 60mm between numbers and/or letters on the sail.

230mm sail numbers

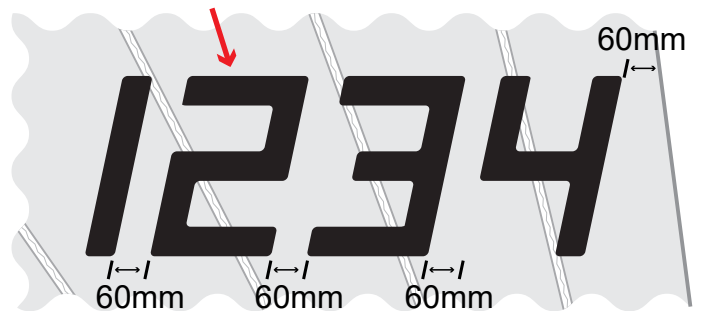

d)



There are also faint lines on the sail to show where to place the national letters (although these are optional and not supplied as standard.)

e) Add the clew strap.

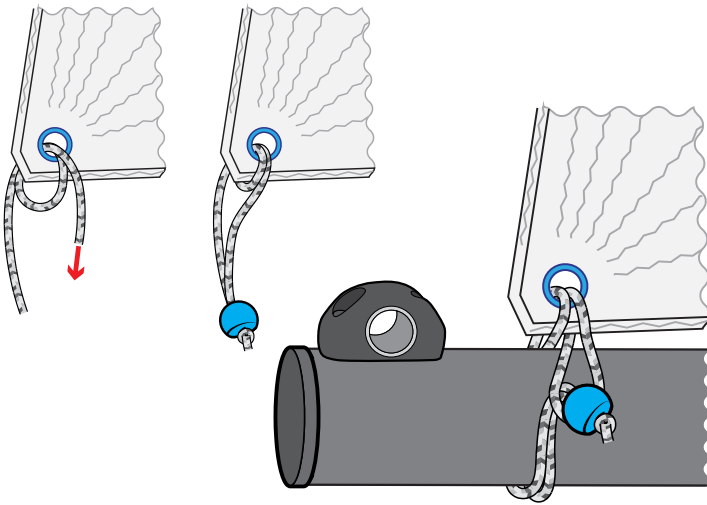

f) Pass a loop of the outhaul rope through clew ring and over the bobble.

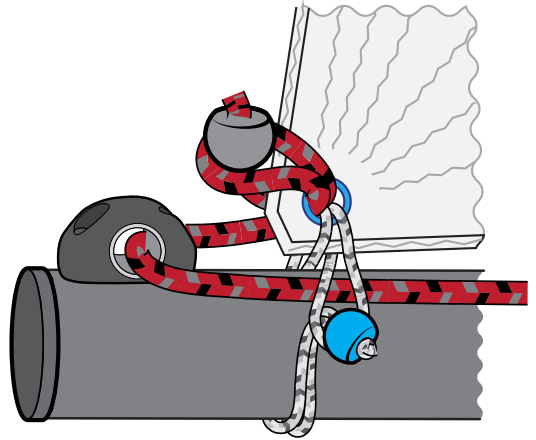

g)



Check there are no twists around the mast.

Attach the main halyard to the sail.

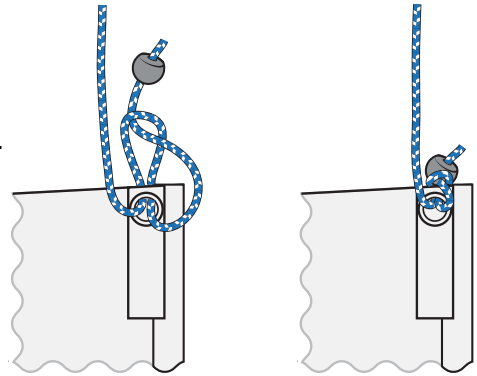

h)



Make sure the boat is head to wind.

Insert the mainsail into the track on the mast.

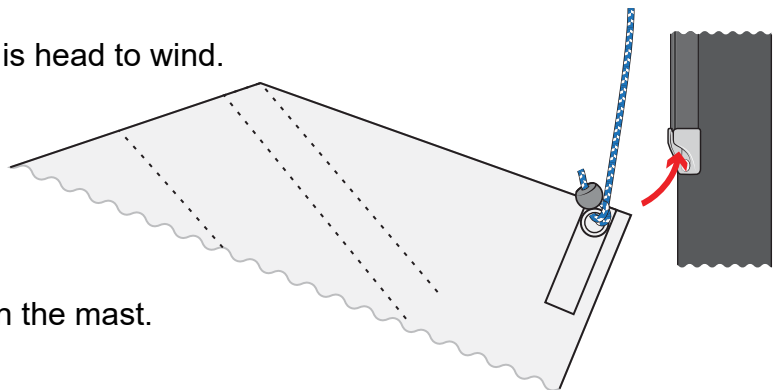

i)

Hoist the main halyard.

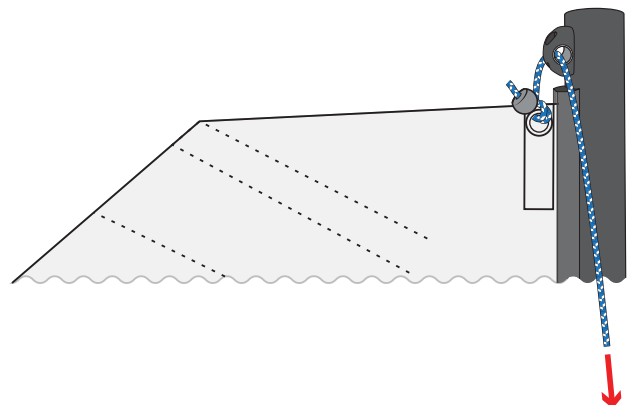

j)

Cleat the main halyard in the cleat on the starboard side of the top mast.

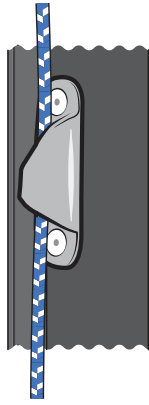

k)

Feed the main halyard tail around the mushroom on the mast.

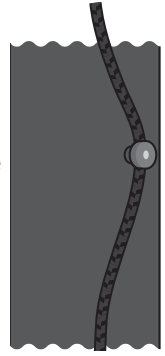

l)

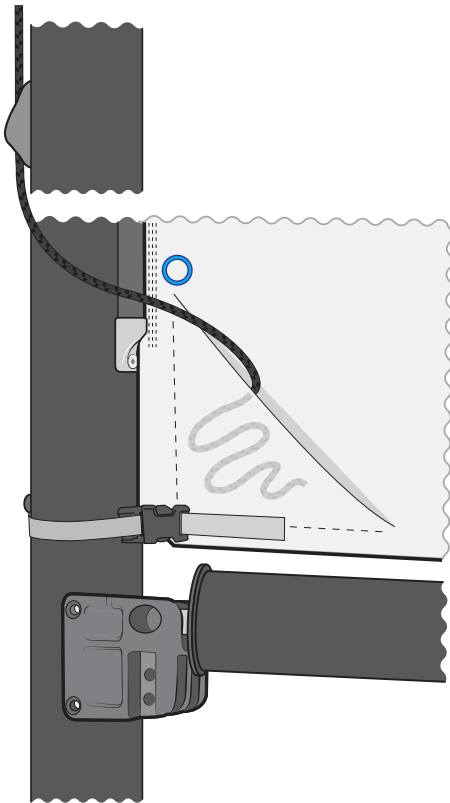

Cleat the halyard tail in the cleat on the front of the mast and tidy into pocket on sail.

m)

Feed the downhaul through the eye on the tack of the sail from starboard to port and tie an overhand knot.

The knot jams in the slot on the port side of the gooseneck.



The downhaul must go inside the tack strap.

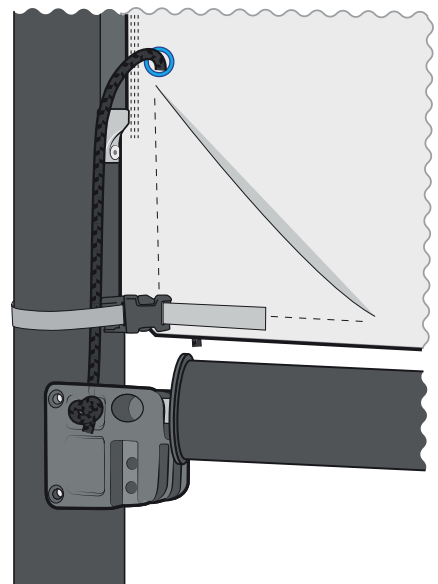

To complete this section, you will need:

- The daggerboard
- Daggerboard retaining elastic
- Daggerboard retaining clip

a)

Tie **knot #3** in the end of the daggerboard elastic and thread it through the hole in the handle.

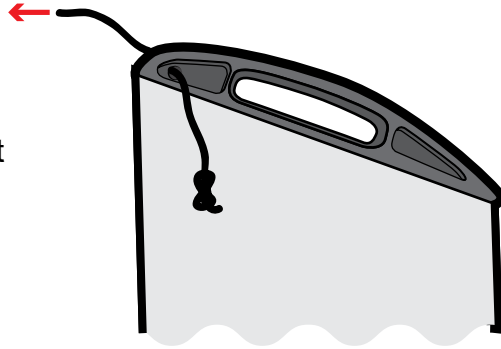

b)

Tie the other end to the plastic clip using a **knot #1**.

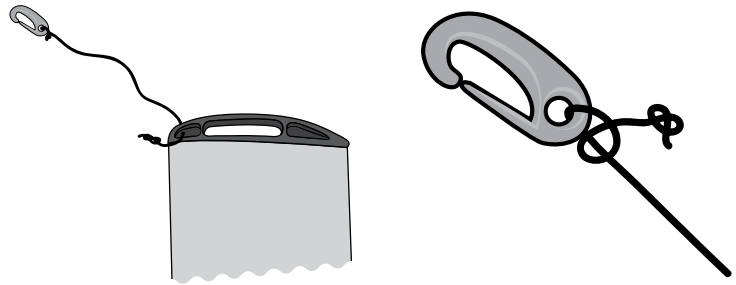

c)

Pass the end of the elastic around the mast (below the kicker) and hook it onto itself.

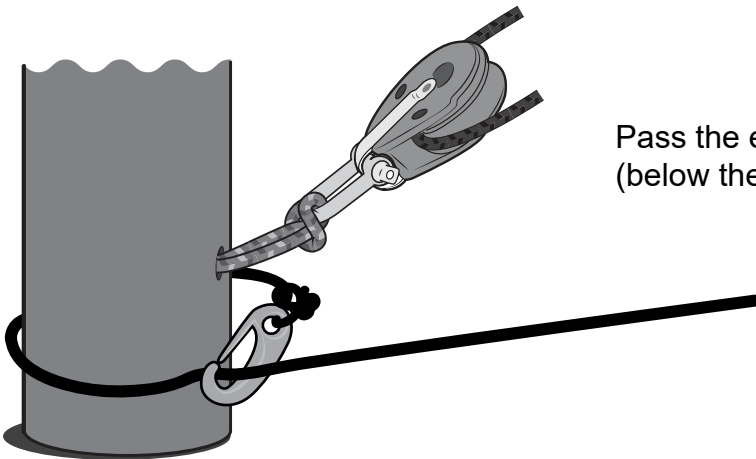

Please note comments in section 6.2 regarding water ingress in foils.

To complete this section, you will require:

- The rudder
- The rudder stock
- The Tiller
- The Tiller retaining screw
- The Tiller extension

a)

Remove the rudder assembly from the foil pack and locate the components. The self-tapping screw is in a small bag, in with the tiller arm.

b)

Slide the Tiller into the stock and fix it with the self-tapping screw.

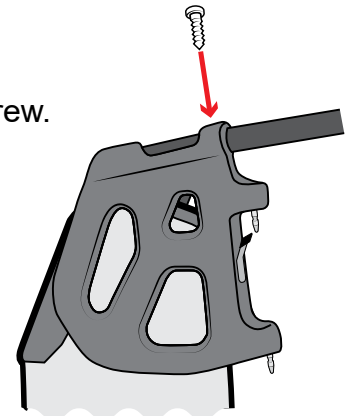
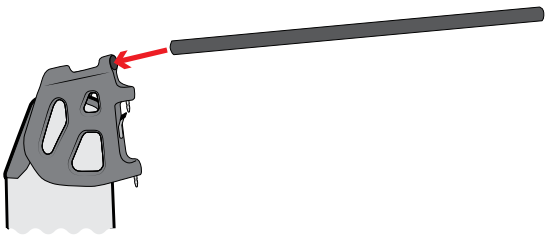

c)

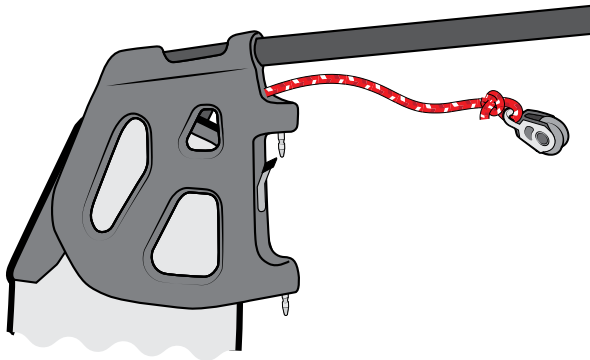

Tie the rudder downhaul block onto the rope from the Rudder blade.

d)

Attach the tiller extension.

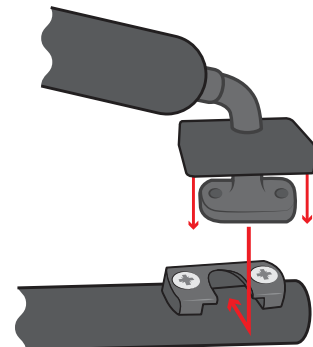

Please note comments in section 6.2 regarding water ingress in foils.

***RS* neo**

4. Completion



PLEASE FOLLOW RIGGING MANUAL IN THE CORRECT ORDER



***RS* neo**

a)

Now you are almost ready to go Neo sailing.

All that is left to do is:

- Fit the rudder to the back of the boat
- Check that all the knots and shackles are tied securely.
- Check that the bung is securely in the back of the boat.

To fit the rudder, simply line up the pins on the rudder stock with the fitting on the back of the boat and push down until the retaining clip 'clicks' into place.

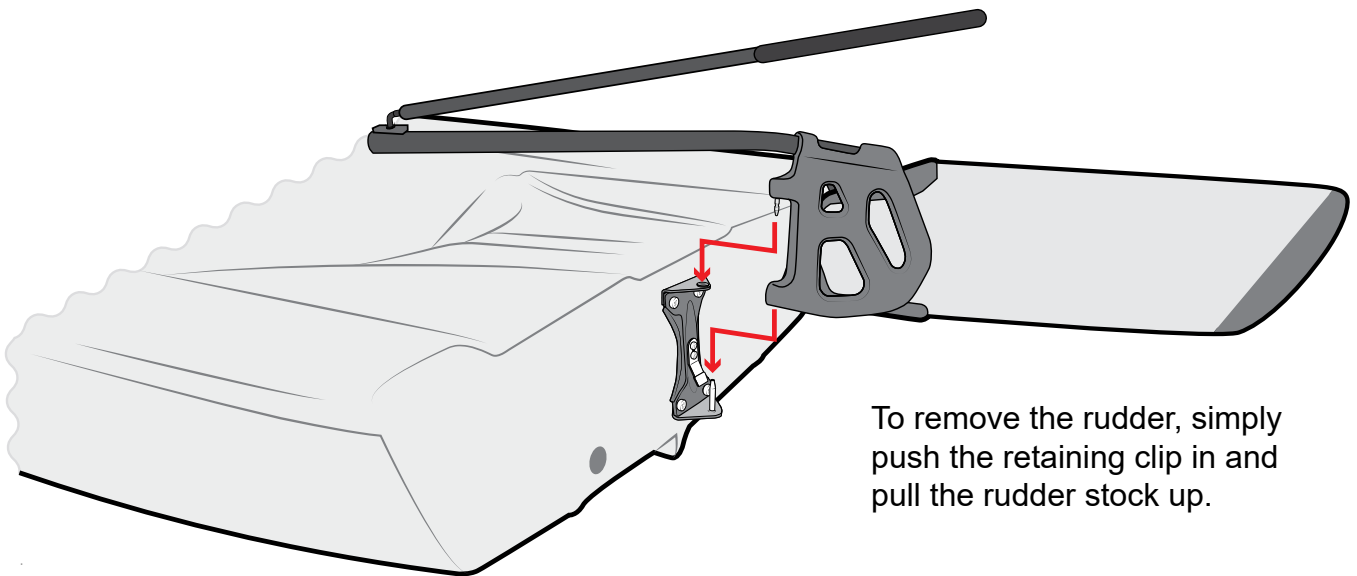

To remove the rudder, simply push the retaining clip in and pull the rudder stock up.



The rudder may be difficult to get on at first – all it will need is a simple wiggle from side to side whilst pushing down.

b)

TIME TO GO SAILING!

After launching, the rudder is lowered by pulling the rudder downhaul line and cleating it.

The daggerboard can be inserted in the daggerboard case when the water is deep enough, make sure the retaining elastic is clipped to the mast!

It is normally best to leave the kicking strap loose while launching, pulling it on as appropriate once you are sailing.

TOP TIP

Make sure that you un-cleave the rudder and raise the daggerboard before coming ashore.

RS neo

5. Sailing Hints



PLEASE FOLLOW RIGGING MANUAL IN THE CORRECT ORDER



RS neo

RS neo 5.1 - Introduction

The RS Neo is a very rewarding boat to sail – to fully appreciate its handling, you should be comfortable with the basic techniques of sailing small boats. If you lack confidence or feel that a refresher is in order, there are many approved sailing schools which use the RS Neo. See www.rya.org.uk for more information.

While we offer you a few hints to aid your enjoyment of your new boat, they should not be considered as a substitute for an approved course in dinghy sailing. In order to build your confidence and familiarise yourself with your new boat, we recommend that you choose a fairly quiet day with a steady wind for your first outing.

RS neo 5.2 - Launching

With the sails fully hoisted and the rudder attached to the transom, the boat should be wheeled into the water, keeping it head to wind as far as possible. If you have a crew, s/he can hold the boat head to wind whilst the trolley is stowed ashore.

If the tide is coming in as you launch, make sure that you leave the trolley far enough up the beach that it will not be swept away.

RS neo 5.3 - Leaving the Beach

The easiest way to get going is for the helm to hop aboard while the crew holds the boat. The helm should put a little daggerboard down, move back to

their normal position, and pull gently on the rudder downhaul to lower some of the rudder blade. Then, s/he may instruct the crew to push the bow off the wind and climb in. The crew will then lower the daggerboard as depth allows. The retaining elastic should be tied on as soon as possible to prevent the board falling out in the event of a capsize.

The singlehanded sailor may choose to ask someone to help them to launch. If launching alone, stand in the water alongside the gunwale, holding the boat head to wind. Lower part of the daggerboard and rudder, and then push the bow off the wind while hopping in.

As soon the water is deep enough, make sure that you lower the rudder blade fully by pulling the rudder downhaul hard. You will know it is fully down if you feel a gentle "thud" as the front face of the blade hits the front face of the stock. Cleat the downhaul and tidy it by winding it around the tiller. Pull the sail in and you are away!

For the best performance, you should ensure that position yourself so that the boat is sailing through the water as flat as possible. Watch the trim (fore and aft) and the heel. The boat should always be sailed as upright as possible.

Top Tip

As a general rule, sit further forward in lighter winds and further aft in stronger breezes.

RS neo 5.4 - Sailing Close Hauled and Tacking

When sailing close-hauled, or as close as possible to the wind, it is important to get the boom as near as possible to the centreline. The kicking strap should be firmly tensioned for upwind work. To pull it on, quickly put the boat head to wind. You should hold the tiller extension across your body, with a knuckles- up grip, enabling you to use one or two fingers as a temporary cleat when adjusting the mainsheet.

To tack, push the tiller extension away from you and, as the boat starts to turn, step across the cockpit facing forwards. Once the boat has completed the turn, bring the tiller back into the centre before sitting down on the new side, with the tiller extension behind your back. When you are settled, swap the mainsheet and the tiller extension into the new hands.

If the boat slows right down and feels lifeless when close-hauled, you could be sailing too close to the wind. Ease the mainsheet and 'bear off' away from the wind for a while to get the boat going again.

RS neo 5.5 - Sailing Downwind and Gybing

When sailing downwind, the sail should be let out until about 90 degrees to the centre line. To gybe, pull the tiller towards you and, as the boat starts to turn, step across the cockpit facing forward. Once the boat has completed the turn, bring the tiller back into the centre before sitting down on the new side, with the tiller extension behind your back. Often, the boom will not want to come across until you have nearly completed the gybe, so it often pays to give the mainsheet a tweak to encourage the boom over at the moment that you want it to come! Once you are settled, swap the mainsheet and the tiller extension into the new hands.

Mind your head when you gybe!

RS neo 5.6 - Top Cover

- a) The top cover is a very simple water-proof cover that can keep the spars and sails dry and out of sight when the boat is not in use. It is best to attach the top cover from the bow and work backwards, pulling the elastic drop cloth into place.

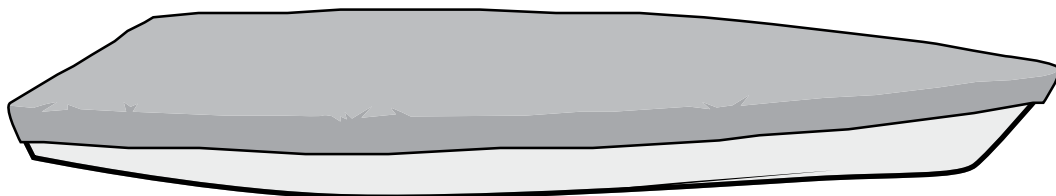

RS neo

6. Maintenance



PLEASE FOLLOW RIGGING MANUAL IN THE CORRECT ORDER



RS neo

The RS Neo is made using Comptec PE3, a three-layer polyethylene construction. This is stiff and light, but will dent if subjected to point loading. The boat should be supported ashore on an approved RS trolley, as the hull may distort if not supported properly. For long-term storage, it is better to support the boat on a rack, in slings, or another type of support that spreads the weight and avoids point loads. The hull can also be stored on the transom, but never store the boat for long periods on its side. When dealing with a marine environment, equipment gets wet; this in itself is not a problem. The problem starts when moisture is trapped for any length of time. Therefore, it is very important to store the boat properly ashore.

Keep your dinghy drained and well ventilated

Ensure that the boat is stored with the bow raised to allow water to drain away.

Wash with fresh water

Fresh water evaporates far more quickly than salt water so if your dinghy has been sailed in salt water, rinse it thoroughly. The fittings will also work better if regularly washed. Any stubborn marks on the hull can be removed with a light detergent, such as washing up liquid. Always test cleaning products on a small, inconspicuous part of the deck before applying to the whole boat.

Hull damage falls into three categories:

- **SERIOUS** – large hole, split, crack, or worse. Don't be too distressed! Get the remnants back to RS Racing so we can assess the damage.
- **MEDIUM** – small hole or split. If this occurs during an event, sailing can often be continued as long as leaking can be prevented by drying the area and applying strong adhesive tape. **CAUTION** – if the damage is close to a heavily loaded point, then the surrounding area should be closely examined to ensure that it will accept the loads. Get the damage professionally repaired as soon as possible.
- **SMALL** – dents, scratching. This type of damage is not boat threatening.

Comptec PE3 cannot be repaired in the same way as fibre glass. Some scratching can be removed by RS Racing staff, but dents cannot. Therefore we suggest you treat your boat with as much care as you would if it were fibre glass. More serious repairs can be carried out by RS Racing staff; however, the repair will never be invisible, due to the nature of the material.

The joy of owning an RS Neo is that it is very hard wearing, and any dents and scratches it receives will not affect the structural integrity of the hull.

RS neo 6.2 - Foil Care

RS Sailing foils are manufactured from anodised Aluminium extrusions with injection moulded glass reinforced Nylon ends. Lower mouldings are bonded in with polyurethane adhesive sealant. Upper mouldings are riveted or screwed in.

Lower mouldings are sealed, however over time there may be some water ingress. If this occurs foils should be inverted to allow water removal through the drain holes in the top of the moulding.

Foils contain closed cell foam to ensure buoyancy and limit potential water ingress.

Maintenance

- Foils should be rinsed with fresh water after use.
- Anodising will prevent surface corrosion, however if surface damage does occur the aluminium should be polished with wax polish e.g. car polish.
- Nylon mouldings are maintenance free and can be sanded smooth if damaged.
- If you run aground hard with the daggerboard down, you should check that the hull has not been punctured at the front or the trailing edge of the daggerboard case. Special 'shock absorbing' pads have been fitted at these points to reduce the risk of damage, and these can be replaced if damaged.

If you are going to trail your boat frequently, you may wish to invest in some RS Racing padded rudder bags. These will protect your RS Neo from any damage caused by the foils.

RS neo 6.3 - Spar Care

The mast and boom are made from carbon fibre. Wash with fresh water as often as possible, both inside and out. Check all of the riveted fittings on a regular basis for any signs of corrosion or wear.

RS neo 6.4 - Sail Care

The mainsail and Jib should be rolled and stored dry, out of direct sunlight. When using a new sail for the first time, try to avoid extreme conditions as high loads on new sailcloth can diminish the racing life of the sail.

If your sail is stained in any way, try to remove it using a light detergent and warm water. DO NOT attempt to launder the sail yourself.

A sail can be temporarily repaired using a self-adhesive cloth tape, such as Dacron or Mylar. The sail should be returned to a sail maker for a professional repair. Check for wear and tear, especially around the batten pockets, on a regular basis.

RS neo 6.5 - Fixtures and Fittings

All of the fixtures and fittings have been designed for a specific purpose in the boat. These items may break when placed under any unnecessary load, or when used for a different function to their intended purpose. To ensure optimum performance, wash the fixtures and fittings with fresh water regularly, checking shackles, bolts, etc. for tightness.

- 1.** This warranty is given in addition to all rights given by statute or otherwise.

- 2.** RS Sailing warrants all boats and component parts manufactured by it to be free from defects in materials and workmanship under normal use and circumstances, and the exercise of prudent seamanship, for a period of twelve (12) months from the date of commissioning by the original owner. The owner must exercise routine maintenance and care.

- 3.** This warranty does not apply to defects in surface coatings caused by weathering or normal use and wear.

- 4.** This warranty does not apply if the boat has been altered, modified, or repaired without prior written approval of RS Sailing. Any changes to the hull structure, deck structure, rig or foils without the written approval of RS Sailing will void this warranty.

- 5.** Warranty claims for materials or equipment not manufactured by RS Sailing can be made directly to the relevant manufacturer. RS Sailing warrants that these parts were installed correctly and according to the instructions provided by the manufacturer.

- 6.** Warranty claims shall be made to RS Sailing as soon as practicable and, in any event, within 28 days upon discovery of a defect. No repairs under warranty are to be undertaken without written approval of RS Sailing.

- 7.** Upon approval of a warranty claim, RS Sailing may, at its expense, repair or replace the component. In all cases, the replacement will be equal in value to the original component.

- 8.** Due to the continuing evolution of the marine market, RS Sailing reserves the right to change the design, material, or construction of its products without incurring any obligation to incorporate such changes in products already built or in use.

Knot #1



Knot #2



Knot #3



Knot #4



Knot #5



Knot #6



Knot #1 - Knot on knot

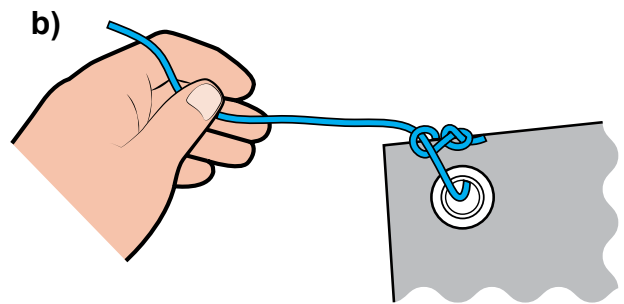
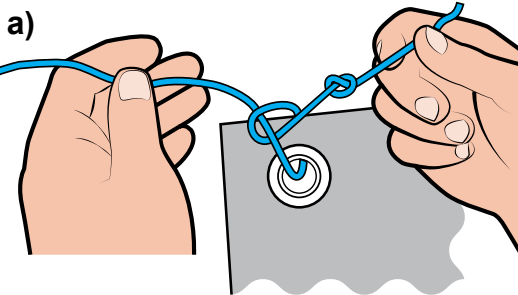

Knot #2 - Bowline

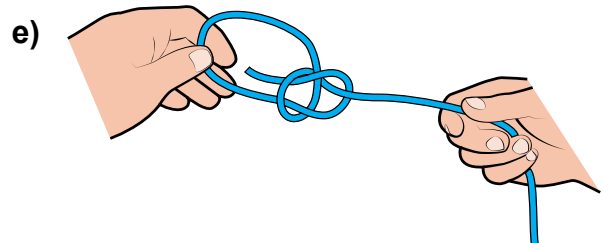
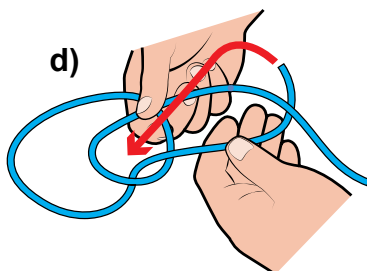
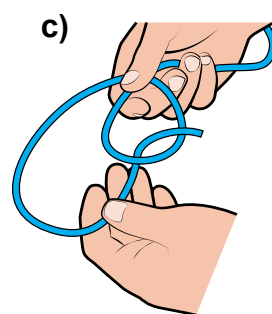
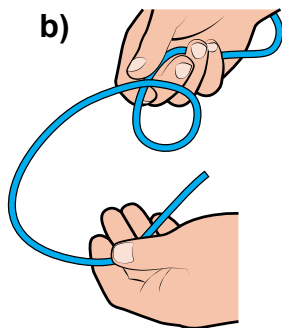
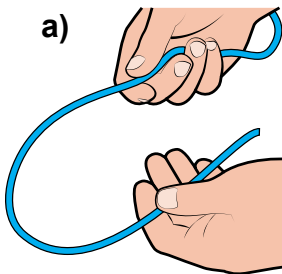

Knot #3 - Figure of eight

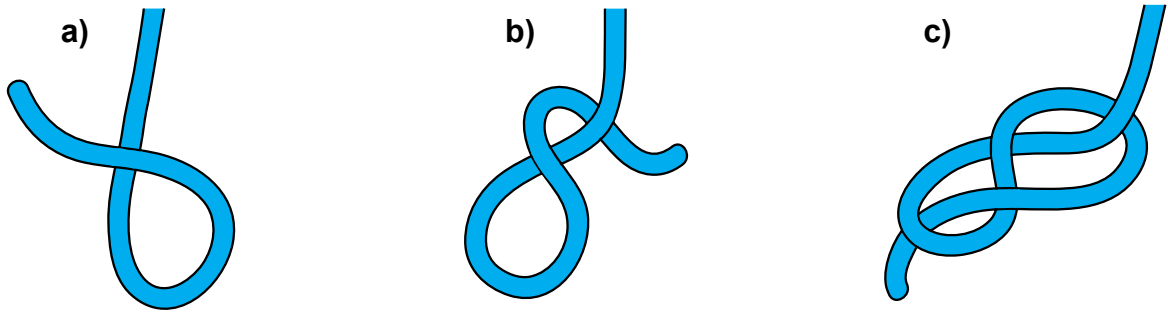

Knot #4 - Overhand knot

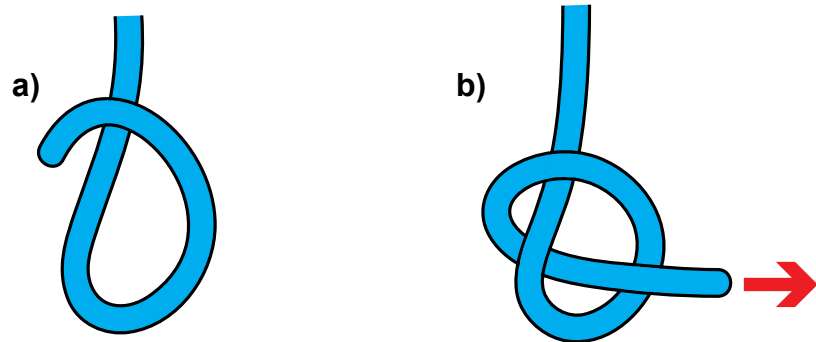

Knot #5 - Double sheet bend

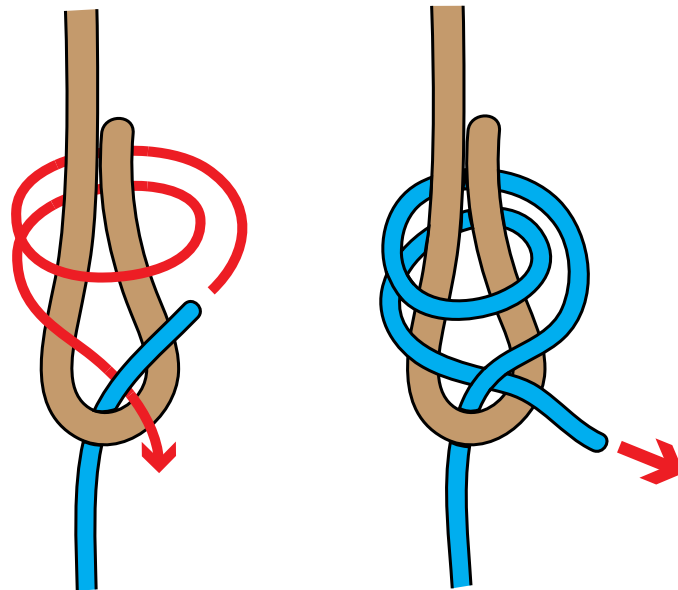

Knot #6 - Cow hitch

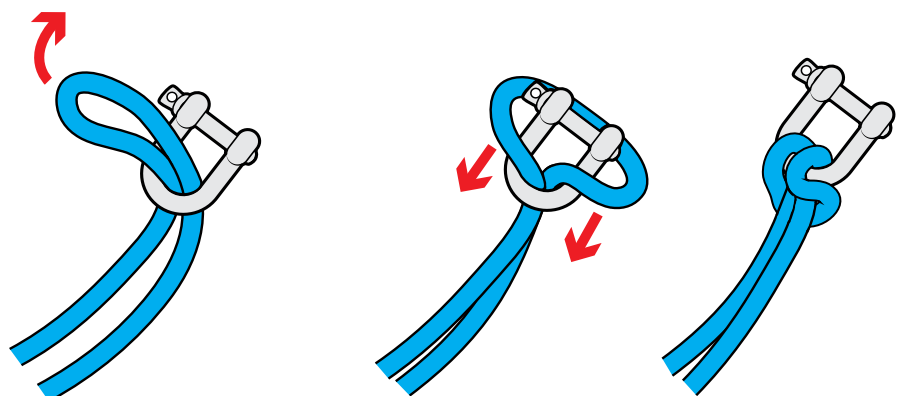

A

Aft	At the back
Anchor Line	Rope that attaches the anchor to the boat
Astern	Behind the boat
Asymmetric	Gennaker flown from a retractable pole at the bow

B

Back	To 'back the sail'; allowing the wind to fill the back of the sail
Bailer	A bucket or other container used for bailing water
Batten	A thin strip of wood/plastic inserted in the sail to keep it flat
Batten Key	A key used to adjust the batten
Batten Pocket	A pocket on the sail that holds the batten
Beam	Width of the boat at the widest point of the side of the boat. The phrase 'wind on the beam' means that the wind is coming from the side.
Bear away	To turn downwind
Beat	To sail a zig-zag course to make progress upwind
Beaufort Scale	A measure of wind strength, from Force 1 to Force 12
Bilge Rail	The moulded line that marks the transition from the side to the bottom of the hull
Block	A pulley used for sail control lines
Boom	The spar at the bottom edge of sail
Boom Pad	The pad that fits onto the boom
Bow	The front of the boat
Bow Lifting Handle	The handle at the front of the boat, used for lifting
Bowline	A useful and reliable knot, with a loop in it
Bow Snubber	The part of the trolley that the bow rests on
Builder's Plate	Plate that contains build information
Bung	A stopper for the drain hole

Buoy	Floating object attached to the bottom of sea – used variously for navigation, mooring, and to mark out a race course
Buoyancy Aid	Helps you to stay afloat if you fall in the water
Buoyancy Compartment	Water-tight compartment in the hull that maintains buoyancy
Burgee	Small flag at the top of the mast to show wind direction

C

Capsize	To overturn
Capsize Recovery	To right, or recover, the boat after a capsize
Catamaran	A boat with two hulls
Centreboard	The foil that sits below the hull to counteract the sideways push of the wind, and to create forward motion
Centreboard Case	The casing in the hull in which the centreboard sits
Centreline	An imaginary line that runs through the centre of the hull, from the bow to the stern
Chart datum	Depths shown on a chart, at the lowest possible tide
Cleat	A device to grip ropes and hold them in place – some grip automatically, while others need the rope tying around them
Clew	Lower corner of the sail, closest to the stern
Close hauled	Sailing as close to the wind as you can; point of sailing to sail upwind
Cockpit	The open area in the boat providing space for the helm and the crew
Collision Regulations	The 'rules of the road' to avoid collisions
Compass Rose	The compass shown on a chart to aid navigation
Crew	Helps the helmsman to sail the boat, and usually handles the jib sheets
Cutter	A boat with two headsails or jibs

D

Dacron	A brand of polyester sailcloth that is wrinkle-resistant and strong
Deck	A floor-like surface occupying part of the hull
Deck Moulding	A moulded deck
Downhaul	Applies downwards tension to a sail
Downwind	To sail in the direction that the wind is blowing
Drain Hole	A hole in the hull from which trapped water can be drained

Draught The depth of the vessel below the surface

E

Ease To 'ease sheets' means to let the sail out gently

F

Fairlead A pulley block used to guide a rope to avoid chafing

Foils The daggerboard and the rudder

Foot The bottom edge of a sail

Fore Towards the front of the boat

Forestay The wire line that runs from the front of the mast to the bow of the hull, holding the mast in position

Furl To gather a sail into a compact roll and bind it against the mast or forestay

G

Gennaker A large sail that is hoisted when sailing downwind

Gennaker Chute Webbing pocket in which the gennaker is stowed when not hoisted

Gennaker Pole The sprit that protrudes from the front of the hull, to which the tack of the gennaker is attached

Gnav Bar Bar that sits between the mast and the boom, performing the same function as a kicking strap

Gnav Control Line Line that applies and releases tension to the gnav

Gooseneck The 'jaws' of the boom that clip onto the mast

Gunwhale The top edge of the hull, that you sit on when leaning out to balance the boat

Gybe To change tack by turning the stern of the boat through the wind.

H

Halyard The rope used to hoist sails

Halyard Bag Bag attached to the hull, in which the halyards can be stowed

Head The top corner of a sail

'Head to Wind'	To point the bow in the direction that the wind is blowing from, causing the sails to flap
'Heave to'	To stop the boat by easing the main sheet and backing the jib
Heel	A boat 'heels' when it leans over due to the sideways force of the wind
Helm/Helmsman	The person who steers the boat, or another name for the tiller
Hoist Block	Block behind which the gennaker halyard is pulled when hoisting the gennaker
Hull	The hollow, lower-most part of the boat, floating partially submerged and supporting the rest of the boat

I

'Into the Wind'	To point the bow in the direction that the wind is blowing from, causing the sails to flap
Inversion	A capsized where the boat turns upside down, or 'turtles'

J

Jammer	Another word for a cleat
Jib	The small sail in front of the mast
Jib Sheet	The rope used to control the jib

K

Kicking strap	The rope system that is attached to the base of the mast and the boom, helping to hold the boom down
Knot	A measurement of speed, based on one minute of latitude

L

Launching	To leave the slipway
-----------	----------------------

Latitude	Imaginary lines running parallel round the globe from east to west. They help you measure position and distance on a chart.
Leech	The back edge of the sail
Leeward	The part of the boat furthest away from the direction in which the wind is blowing
Leeway	The amount of sideways drift caused by the wind
Leverage	The result of using crew weight as a 'lever' to counteract heel caused by the wind
Lie to	A way of stopping the boat temporarily by easing sheets on a close reach
Lifjacket	Unlike a buoyancy aid, a lifjacket will keep a person fully afloat with their head clear of the water
Longitude	Imaginary lines running round the globe from north to south, like segments of an orange. Used with lines of latitude to measure position and distance
Lower Furling Unit	The fitting at the bottom of the forestay that enables the jib to be furled
Luff	The front edge of the sail

M

Mainsail	The largest sail on a boat
Mainsail Clew Slug	The fitting that sits in the track on the boom, to which the clew of the mainsail is attached
Mainsheet	The rope used to control the mainsail
Mainsheet Bridle	The rope runs across the transom of the boat, to which the mainsheet is attached
Mainsheet Centre Block	The main block, usually fixed to the cockpit floor, through which the mainsheet passes
Man Overboard Recovery	The act of recovering a 'man overboard' from the water
Mast	The spar that the sails are hoisted up
Mast Foot	The bottom of the mast
Mast Gate	Fitting which closes across the front of the mast at deck level, holding the mast in place

Mast Lower Section	The bottom section of a two-piece mast
Mast Step	The fitting on the deck that the mast fits into
Mast Top Section	The top section of a two-piece mast
Meteorology	The study of weather forecasting
Moor	To tie the boat to a fixed object
Mylar	A brand of strong, thin, polyester film used to make racing sails

N

National Sailing Federation	Body that governs sailing in a nation. In the UK, this is the Royal Yachting Association
Navigation	To find a way from one point to the other
Neap Tide	Tides with the smallest tidal change

O

'Off the Wind'	To sail in the direction that the wind is blowing
Outboard Bracket Kit	Bracket which enables an outboard engine to be attached to the transom
Outboard Engine	Small portable engine that attaches to the transom
Outhaul	The control line that applies tension to the foot of the sail, by pulling the sail along the boom
Outhaul Hook	The fitting on the boom that hooks the eye at the back of the sail, and to which the outhaul is attached

P

Painter	The rope at the bow used to tie the boat to a fixed object
Pontoon	A floating jetty to moor your boat to
Port	The left-hand side of the boat, when facing forwards

R

RS Dealer	A third-party who sells the RS range
Reach	Sailing with the wind on the side of the boat

Reef	To make the sails smaller in strong winds
Retaining Pin	On a trolley, to hold the launching trolley to the road base
Road Base	A trolley that you place your boat and launching trolley upon to trail behind a vehicle
Rowlocks	U shaped fittings that fix onto the gunwale and holds your oars in position while rowing
Rowlock Holes	The holes in the gunwhale into which the rowlocks fit
Rudder	The foil that, when attached to the stern, controls the direction of the boat
Rudder Blade	The large, rigid, thin part of the rudder
Rudder Downhaul	The control line that enables you to pull the rudder into place
Rudder Pintle	The fitting on the transom onto which the rudder stock fits
Rudder Stock	The top part of the rudder, usually including the tiller, into which the rudder blade fits, and which then attaches to the rudder pintle
Run	To 'run with the wind', or to sail in the direction that the wind is blowing

S

Safety-Boat Cover	Support boats, usually RIBs, in case of emergency
Sail	An area of material attached to the boat that uses the wind to create forward motion
Sailmaker	A manufacturer of sails
Sail Number	The unique number allocated to a boat, displayed on the sail when racing
Sail Pressure	A sail has 'pressure' when it is working with the wind to create motion
Sailing Regatta	An event that usually comprises of a number of sailing races
Shackle	A metal fitting for attaching ropes to blocks, etc.
Shackle Key	Small key used to undo tight shackles
Sheet	A rope that controls a sail
Shroud	The wires that are attached to the mast and the hull, holding the mast up
Side Safety Line	The line that runs along the side of the hull
Single Handed	To sail a boat alone
Single-Line Reefing System	An efficient method of reefing with one line

Slider	Sliding fitting on the boom to which the gnav bar is attached
Soundings	The numbers on a chart showing depth
Spars	The poles, usually carbon or aluminium, to which the sail is attached
Spreaders	Metal fittings attached to the mast which hold the shrouds out
Spring Tide	The tides with the biggest range and strongest currents
Starboard.	The right-hand side of the boat, when facing forwards
Stern	The back of the boat
Stern Lifting Handles	The handles at the stern, used for lifting the boat
Stopper Knot	A form of knot used to prevent a rope from sliding through a fitting, such as a pulley or a cleat

T

Tack	a) To change direction by turning the bow of the boat through the wind b) The bottom front corner of a sail
Tack Bar	The bar at the bow of the hull, to which the tack of the jib is attached
Tack Line	The rope that emerges from the front of the gennaker pole, to which the tack of the gennaker is attached
Tender	A small vessel, usually used to transport crew to a larger vessel
Tidal height	The depth of water above chart datum
Tidal range	The difference between the depth of water at low and high tide
Tidal stream	The direction in which the tide is flowing
Tiller	The stick attached to the rudder, used to steer the boat
Tiller Extension	A pole attached to the tiller to extend its reach, usually used when hiking
Toe Straps	The straps to tuck your feet under when you lean out to balance the boat.
Top Furling Unit	Fitting at the top of the forestay which enables the jib to be furled
Towing Line	A rope attached to the boat, used to connect to a towing vessel
Transit	An imaginary line between two fixed objects, used to ensure that you are staying on course
Transom	The vertical surface at the back of the boat
Trim	Keeping the boat level fore and aft
Trimaran	A boat with three hulls
Trolley	A wheeled structure, used to move the boat around on land
Trolley Supports	The part of the trolley in direct contact with the hull

U

'Under Weigh' A term derived from the act of 'weighing' anchor, meaning to be in motion

Upwind To sail against the direction in which the wind is blowing

W

Wetsuit Neoprene sailing suit designed to keep you warm when wet

Windward The part of the boat closest to the direction in which the wind is blowing